

Precision tools



Precision tweezers

LCR Tester / LED tester	384
Wiha Professional ESD	385
KNIPEX	386
CK	388
Ideal-tek	392
Erem Precision tweezers	405
Piergiacomì	409

Screwdrivers

Piergiacomì Screwdrivers	413
CK Screwdrivers	413
Wiha Screwdrivers	417
WERA Screwdrivers	426
Torque screwdrivers ESD WERA	427
WERA Bit holder / Bits	427

Bit inserts

Bit inserts	429
-------------	-----

Torque screwdrivers

Torque screwdrivers ESD	432
Torque screwdrivers VDE	433
Torque screwdrivers	434

Electric screwdrivers

Electric screwdrivers Kilews	436
Control units Kilews	443
Accessories Kilews	444
Electric screwdrivers Delvo	445
Control units Delvo	446
Accessories Delvo	446
Accessories electric screwdrivers	446

Support arm and torque support

Support arm and torque support	447
--------------------------------	-----

Torque measurement instruments

Torque testers	449
----------------	-----

Screw separating units

Screw separating units	449
------------------------	-----

Pliers

ideal-tek Pliers	450
Piergiacomì	456
CK	463
Wiha	470
Knipex	473
Lindstrom	481
Erem	483

Stripping / crimping

Piergiacomì	488
CK	489
Knipex	489
High-precision stripping tool	493

Other tools

Scalpels and scissors	493
CK	495
Wiha	496
Knipex	497

Pneumatic cutter

Pneumatic cutter	499
------------------	-----

Processing tools

Insertion and processing tools	501
Processing tools	501

Handling systems

Handling systems	501
------------------	-----

Precision tweezers

LCR Tester / LED tester

SMART TWEEZERS LCR multimeter



Digital, automatic LCR measuring instrument, integrated in a pair of handy tweezers, for quick measurement of small SMD components. Light, ergonomic measuring head, automatic setting of component type and measuring range, multifunctional display showing the measurement parameters. Voltage range of 0.8-8V, measured parameters: C, L, R, ESR, RS, RP

Technical data

Working temperature: 0°C to +55°C

Dimensions: 14.0 x 2.5 x 3.0 cm (3.94 x 0.9 x 1.5 inches)

Weight: 53 g (0.111lb)

Measured parameters: C + R (EPR), L + R, R

Measured frequency: 100 Hz, 1 kHz, 10 kHz

Measurement rate: 4.0, 2.1, 0.5 per second (default I)

DC voltage: 0 to 800 mV (up to 8 V with manual setting)

Resistance: 0.1 to 5 MOhm

Capacity: 1 pF to 4999 µF (1 pF - 5 pF m.) (with manual setting)

Inductive resistance: MH 1 µH to 499 (1 µH - 4 µH m.) (with manual setting)

Resistance:

Measuring range: 10 Ohm - 5 MOhm

Accuracy: 1% + 0.02 in the measuring range of 10 Ohm - 5 MOhm

Test frequency: 1 kHz

Capacity:

Measuring range: 20pF - 4999µF

Accuracy: 3% + 1.7pF * typical deviation 1.6pF at 0402 part size

Resolution: 0.1pF in the measuring range of 1pF - 100 PF

Test frequency: 1 kHz C > 1000pF, 10 kHz C < 1000pF, 100 Hz C > µF

Inductive resistance:

Measuring range: 10µH - 499mH

Accuracy: 3% + 0.4µH * typical deviation 1.4µH at 0402 part size

Resolution: 0.046 in the measuring range of 0.46 - 100µH

Test frequency: 10 kHz L < 1mH > 1mH, 100 Hz L < 10mH

[dpvlink 10022](#)

Article Type

ST-5S **SMART TWEEZERS ST-5**
incl. rechargeable LiPo battery



Exchangeable tips set standard

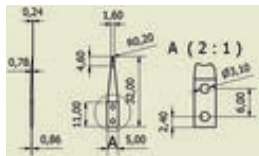

Exchangeable tips set standard (replacement tips) for Smart Tweezers

[dpvlink 13334](#)

Article

ST5-IT-T **Exchangeable tips set standard for ST-5**



Exchangeable tips High Precision Sharp

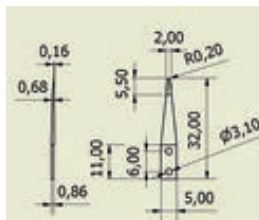

Exchangeable tips set High Precision Sharp (replacement tips) for Smart Tweezers

[dpvlink 13340](#)

Article

ST5-IT-TSHP **Exchangeable tips High Precision Sharp for ST-5**



SMART TWEEZERS Iskra ST5-LED



Automatic, adaptive SMD LED tester with a precise and gold-plated pair of tweezers. Smart Tweezers® Iskra™ is a specialized solution for testing and verification of SMD and through-hole LEDs.

Comfortable one-hand operation, automatic LED polarity detection, forward drop voltage display, adjustable preset test current.

Technical data

Operating temperature: 0°C to +55°C

Dimensions: 15.0 x 1.8 x 1.5 cm (5.9 x 0.7 x 0.6 inch)

Weight: 30 gr (1 oz)

Test current: 1, 2, 5, 10, 20, 30 mA

Duty cycle: 10, 20, 30, 40, 50%

Test signal: 5 Volt (max)

Test current pulse duration: 10 to 1000 msec

Battery type: LiPo, 180 mAh, 20 hours (continuous use)

Charging cycle: 5 Volt, 50 mA direct current, 3 hours

[dpvlink 19484](#)

Article Type

ST-5.LED **SMART TWEEZERS Iskra ST-5**
incl. rechargeable LiPo battery



Wiha Professional ESD



Wiha Professional ESD tweezers for all conventional applications in electronics industry.

- antimagnetic and acid-resistant
- for precise works
- antistatic

Universal tweezers Professional ESD AA



Version: Smooth gripping surfaces, without grooves. Glare-free, black coated, anti-static. Antimagnetic and acid-resistant.

Material: Special alloyed, chrome-nickel stainless steel.

Application: Universal tweezers for all common applications in electronics.

dpvlink 12805 			
Article	Type	L [mm]	
ZP.01014130	Universal tweezers Professional ESD type AA	130 mm	

Universal tweezers Professional ESD 40



Version: Finely serrated gripping surfaces, with grooves. Glare-free, black coated, antistatic. Antimagnetic and acid-resistant.

Material: Specially alloyed, chrome-nickel stainless steel.

Application: Universal tweezers for all common applications in electronics.

dpvlink 12807 			
Article	Type	L [mm]	
ZP.46014145	Universal tweezers Professional ESD type 40	145 mm	

Precision tweezers Professional ESD GG



Version: Smooth gripping surfaces, without grooves. Glare-free, black coated, anti-static. Antimagnetic and acid-resistant.

Material: Specially alloyed, chrome-nickel stainless steel.

Application: Precision tweezers for gripping and holding electronic components.

dpvlink 12809 			
Article	Type	L [mm]	
ZP.06014130	Precision tweezers Professional ESD type GG	145 mm	

Precision tweezers Professional ESD PSF



Version: Smooth gripping surfaces, without grooves. Glare-free, black coated, anti-static. Antimagnetic and acid-resistant.

Material: Specially alloyed, chrome-nickel stainless steel.

Application: Precision tweezers for gripping and holding electronic components.

dpvlink 12811 			
Article	Type	L [mm]	
ZP.07114130	Precision tweezers Professional ESD type PSF	130 mm	

Precision tweezers Professional ESD SS



Version: Smooth gripping surfaces, without grooves. Glare-free, black coated, anti-static. Antimagnetic and acid-resistant.

Material: Specially alloyed, chrome-nickel stainless steel.

Application: Precision tweezers to grip and hold electronic components.

dpvlink 12813 			
Article	Type	L [mm]	
ZP.09014135	Precision tweezers Professional ESD type SS	135 mm	

Precision tweezers Professional ESD 00



Version: Smooth gripping surfaces, without grooves. Glare-free, black coated, anti-static. Antimagnetic and acid-resistant.

Material: Specially alloyed, chrome-nickel stainless steel.

Application: Precision tweezers for gripping and holding electronic components.

dpvlink 12815 			
Article	Type	L [mm]	
ZP.11014120	Precision tweezers Professional ESD type 00	120 mm	

Precision tweezers Professional ESD 2A



Version: Smooth gripping surfaces, without grooves. Glare-free, black coated, anti-static. Antimagnetic and acid-resistant.

Material: Specially alloyed, chrome-nickel stainless steel.

Application: Precision tweezers for gripping and holding electronic components

dpvlink 12817 			
Article	Type	L [mm]	
ZP.15014120	Precision tweezers Professional ESD type 2A	120 mm	

Precision tweezers Professional ESD 3C



Version: Smooth gripping surfaces, without grooves. Glare-free, black coated, anti-static. Antimagnetic and acid-resistant.

Material: Specially alloyed, chrome-nickel stainless steel.

Application: Precision tweezers for gripping and holding electronic components.

dpvlink 12819 			
Article	Type	L [mm]	
ZP.16014110	Precision tweezers Professional ESD type 3C	110 mm	

Precision tweezers Professional ESD 5



Version: Smooth gripping surfaces, without grooves. Glare-free black coated, anti-static. Antimagnetic and acid-resistant.

Material: Specially alloyed, chrome-nickel stainless steel.

Application: Precision tweezers for gripping and holding electronic components.

dpvlink 12821 			
Article	Type	L [mm]	
ZP.18014110	recision tweezers Professional ESD type 5	110 mm	

Precision tweezers

Precision tweezers Professional ESD 7A



Version: Smooth gripping surfaces, without grooves. Glare-free black coated, anti-static. Antimagnetic and acid-resistant.

Material: Specially alloyed, chrome-nickel stainless steel.

Application: Precision tweezers for gripping and holding electronic components.

[dpvlink 12823](#)

Article	Type	L [mm]
ZP.20114120	Precision tweezers Professional ESD type 7A	120 mm



Precision tweezers Professional ESD 7ABB



Version: Smooth gripping surfaces, without grooves. Glare-free black coated, anti-static. Antimagnetic and acid-resistant.

Material: Specially alloyed, chrome-nickel stainless steel.

Application: Precision tweezers for gripping and holding electronic components.

[dpvlink 12825](#)

Article	Type	L [mm]
ZP.20214120	Precision tweezers Professional ESD type 7ABB	120 mm



SMD tweezers Professional ESD 12



Version: Smooth gripping surfaces, without grooves. Glare-free black coated, anti-static. Antimagnetic and acid-resistant.

Material: Specially alloyed, chrome-nickel stainless steel.

Application: Precision tweezers for gripping and holding electronic components.

[dpvlink 12827](#)

Article	Type	L [mm]
ZP.24014120	SMD tweezers Professional ESD type 12	120 mm



SMD tweezers Professional ESD 13



Version: Smooth gripping surfaces, without grooves. Glare-free black coated, anti-static. Antimagnetic and acid-resistant.

Material: Specially alloyed, chrome-nickel stainless steel.

Application: Precision tweezers for gripping and holding electronic components.

[dpvlink 12829](#)

Article	Type	L [mm]
ZP.25214120	SMD tweezers Professional ESD type 13	120 mm



SMD tweezers Professional ESD 59



Version: Smooth gripping surfaces, without grooves. Glare-free black coated, anti-static. Antimagnetic and acid-resistant.

Material: Specially alloyed, chrome-nickel stainless steel.

Application: Precision tweezers for gripping and holding electronic components.

[dpvlink 12833](#)

Article	Type	L [mm]
ZP.50014117	SMD tweezers Professional ESD type 59	117 mm



SMD tweezer set Professional ESD 4-piece



SMD tweezer set Professional ESD 4-piece

manufactured in accordance with IEC 61340-5-1. All tweezers are ESD safe (antistatic) due to a special ESD coating, acid-resistant, stainless and 100% antimagnetic.

consisting of:

-ZP 01 014 130

-ZP 07 114 130

-ZP 25 214 120

-ZP 50 014 117

[dpvlink 13280](#)

Article	Type
ZP99014002.ESD	SMD tweezers set Professional ESD 4-piece



KNIPEX

KNIPEX ESD



KNIPEX ESD Precision tweezers convince by high precision and fineness:

- Chrome / nickel steel, stainless, antimagnetic (18/10), not hardenable
- Brushed, glare-free tips
- Matt gripping surface for optimal grip
- ESD coating, glare-free black.

In compliance with ESD standard DIN EN 61340-5-1 

SMD Universal tweezers set 5-piece

NEU



Manufactured in accordance with DIN 61340-5-1. All tweezers are ESD-safe (antistatic) due to a special ESD coating, stainless and antimagnetic.

Consisting of:

- K-922870.ESD
- K-922871.ESD
- K-922869.ESD
- K-923875.ESD
- K-925874.ESD

[dpvlink 26481](#)

Article	Type
K-9200.01.ESD	SMD Universal tweezers set 5-piece



SMD Plastic tweezers set 5-piece

NEU



Manufactured in accordance with DIN 61340-5-1. All tweezers are ESD-safe (antistatic).

Consisting of:

- 92 09 02 ESD
- 92 09 03 ESD
- 92 09 01 ESD
- 92 09 04 ESD
- 92 09 05 ESD

dpvlink 26485

Article	Type
K-9200.05.ESD	SMD Plastic tweezers set 5-piece



Placement tweezers 920878



for SMD technology, angled tips, smooth gripping surfaces.

dpvlink 8792

Article	Type	L [mm]
K-920878.ESD	Placement tweezers 920878	118



Placement tweezers 920879



for gripping horizontally arranged, cylindrical components with \varnothing 1.0 mm and width 4.0 mm, gripping surface smooth, serrated handles.

dpvlink 8794

Article	Type	L [mm]
K-920879.ESD	Placement tweezers 920879	122



Precision tweezers 922869



straight shape, strong tips, smooth gripping surfaces.

dpvlink 8790

Article	Type	L [mm]
K-922869.ESD	Precision tweezers 922869	120



Precision tweezers 922870



Straight shape, fine tips, smooth gripping surfaces.

dpvlink 8796

Article	Type	L [mm]
K-922870.ESD	Precision tweezers 922870	110



Precision tweezers 922871



Fine tips, straight shape, smooth gripping surfaces.

dpvlink 8798

Article	Type	L [mm]
K-922871.ESD	Precision tweezers 922871	110



Precision tweezers 922872



American style, sturdy, long tips, straight shape, smooth gripping surfaces.

dpvlink 8800

Article	Type	L [mm]
K-922872.ESD	Precision tweezers 922872	130



Precision tweezers 923875



Crescent-shaped tips, smooth gripping surfaces.

dpvlink 8802

Article	Type	L [mm]
K-923875.ESD	Precision tweezers 923875	118



Precision tweezers 925874



Round tips, approx. 2 mm wide, straight shape, smooth gripping surface.

dpvlink 8804

Article	Type	L [mm]
K-925874.ESD	Precision tweezers 925874	118



Precision tweezers 927877



Round tips, approx. 3.5 mm wide, straight, serrated gripping surfaces and handles.

dpvlink 8806

Article	Type	L [mm]
K-927877.ESD	Precision tweezers 927877	145



Precision tweezers

KNIPEX insulated - 1000V



- tested according to IEC 60900: 2004
- dip-insulated
- nickel-plated

SMD Universal tweezers set 5-piece

NEU



Manufactured in accordance with DIN 60900. All tweezers are ESD-safe (antistatic) and insulated.

Kit consists of:

- K-924701
- K-922761
- K-923764
- K-922762
- K-926763

dpvlink 26483

Article	Type
K-9200.04	SMD Universal tweezers set insulated 5-piece



Precision tweezers 922761 insulated



For fine assembly work, extra fine tips, straight shape, gripping surfaces matt for optimal grip.

dpvlink 8810

Article	Type	L [mm]
K-922761	Precision tweezers 922761	125 mm



Precision tweezers 922762 insulated



Straight shape, gripping surfaces finely serrated

dpvlink 8814

Article	Type	L [mm]
K-922762	Precision tweezers 922762	150



Precision tweezers 923764 insulated



Angled tips, gripping surfaces finely serrated.

dpvlink 8816

Article	Type	L [mm]
K-923764	Precision tweezers 923764	148 mm



Precision tweezers 926763 insulated



Straight shape, serrated gripping surfaces.

dpvlink 8818

Article	Type	L [mm]
K-926763	Precision tweezers 926763	145



CK

CK BASIC

BasiC



Basic, the classic all-round range in proven quality for the use in electronics and fine mechanics, schools, workshops.

- High-quality tool steel, polished, nickel-plated or coated
- Some models made of stainless steel, polished, matted
- Different shapes, lengths and thicknesses
- With or without cut

Universal tweezers 2307



Universal tweezers with rounded tips (3.5 mm) and fine cut. Polished and finely nickel-plated. Serrated handles.

dpvlink 21298

Article	Type	L [mm]	Material
2307	Universal tweezers 2307	145	Carbon steel



Reverse-action tweezers (self-clamping) 2313A C



Soldering tweezers with heat-insulating protection plates in the grip area. Tips 2.5 mm, 15 mm bent. Without cut. Polished and finely nickel-plated.

dpvlink 1111

Article	Type	L [mm]	Material
2313A	Reverse-action tweezers (self-clamping) 2313A C	160	Tool steel, hardened



Radio tweezers 2327 C



Rounded, straight tips (2 mm) with fine cut. Polished and finely nickel-plated. Serrated handles. For universal use, suitable for service work in radio, hi-fi and video sectors.

dpvlink 1115

Article	Type	L [mm]	Material
2327	Radio tweezers 2327 C	155	Tool steel, hardened



Radio tweezers 2328 C



Rounded, bent tips (2 mm), with fine cut. Polished and finely nickel-plated. Serrated handles. For universal use, suitable for service work in the radio, hi-fi and video sectors.

dpvlink 1117

Article	Type	L [mm]	Material
2328	Radio tweezers 2328 C	155	Tool steel, hardened



CK PRECISION

precision



The series "Precision" impresses with high precision and fineness and has been adapted to the constantly changing requirements.

- Steel of highest quality, stainless, antimagnetic, acid-resistant.
- Produced with the most modern production methods.
- Controlled bit by bit.
- Finely polished, matt.
- Available in a wide range, many shapes, lengths and thicknesses.

Precision tweezers 2316 SA (18/10)



Fine, straight tips. Finely polished. Austenitic, stainless steel, antimagnetic, acid-resistant.

dpvlink 1119

Article	Type	Length [mm]
2316	Precision tweezers 2316 SA (18/10)	105



Precision tweezers 2317 SA (18/10)



Fine, bent tips. Finely polished. Austenitic, stainless steel, antimagnetic, acid-resistant.

dpvlink 1121

Article	Type	Length [mm]
2317	Precision tweezers 2317 SA (18/10)	105



Precision tweezers 2318 SA (18/10)



Fine, straight, extra long tips. Finely polished. Austenitic, stainless steel, antimagnetic, acid-resistant.

dpvlink 1123

Article	Type	Length [mm]
2318	Precision tweezers 2318 SA (18/10)	130



Precision tweezers 2319 S



Fine, straight tips. Finely polished. Stainless steel.

dpvlink 1125

Article	Type	Length [mm]
2319	Precision tweezers 2319 S	120



Precision tweezers SMD type 5B.SA



Superfine tips, bent by 60°. For various applications.

dpvlink 1127

Article	Type	Length [mm]
2330	Precision tweezers SMD type 5B.SA	110



Precision tweezers SMD type 5C.SA



Superfine tips, bent by 60° and curved. For working in the narrowest spaces.

dpvlink 1129

Article	Type	Length [mm]
2331	Precision tweezers SMD type 5C.SA	115



Placement tweezers SMD type SM104.SA



For an easy, lateral gripping and positioning of components in the SOT case

dpvlink 1143

Article	Type	Length [mm]
2334	Placement tweezers SMD type SM104.SA	120



Placement tweezers SMD type SM115.SA



For the holding and positioning of cylindrical parts up to Ø 1 mm. Tips angled by 30°, rounded inside.

dpvlink 1147

Article	Type	Length [mm]
2336	Placement tweezers SMD type SM115.SA	120



Precision tweezers 2339 SA



Fine, bent tips, Austenitic, stainless steel, anti-magnetic, acid-resistant.

dpvlink 21329

Article	Type	Length [mm]
2339	Precision tweezers 2339 SA	110



Precision tweezers type 3C.SA



Extremely fine, sharp tips, straight. For various applications.

dpvlink 1133

Article	Type	Length [mm]
2340	Precision tweezers type 3C.SA	110



Precision tweezers type 5.SA



Superfine tips, straight. For various applications.

dpvlink 1131

Article	Type	Length [mm]
2341	Precision tweezers type 5.SA	110



Precision tweezers type MM.SA



Fine tips, straight. For various applications.

dpvlink 1135

Article	Type	Length [mm]
2343	Precision tweezers type MM.SA	130



Reverse-action tweezers (self-clamping) SMD type X104.SA



For an easy lateral gripping and positioning of components in the SOT case and for similar applications. Fatigue-free working

dpvlink 1141

Article	Type	Length [mm]
2349	Reverse-action tweezers (self-clamping) SMD type X104.SA	120



Placement tweezers SMD type 582.SA



For the holding, positioning and desoldering of horizontal cylindrical components up to 1 mm \varnothing . Tips rounded inside. Serrated handles.

dpvlink 1157

Article	Type	Length [mm]
2351	Placement tweezers SMD type 582.SA	115



Placement tweezers SMD type 579.SA



For the holding, positioning and desoldering of horizontal cylindrical components up to 2 mm \varnothing . Tips rounded inside. Serrated handles.

dpvlink 1201

Article	Type	Length [mm]
2354	Placement tweezers SMD type 579.SA	115



Placement tweezers type 22.SA



Fine, bent tips with fine cross cut. Serrated handles. For general application.

dpvlink 1225

Article	Type	Length [mm]
2359	Placement tweezers type 22.SA	150



Placement tweezers type 2A.SA



Flat, rounded tips, very finely polished.

dpvlink 1227

Article	Type	Length [mm]
2360	Placement tweezers type 2A.SA	120



Flat gripping tweezers type 127.SA



Spatulate, rectangular, flat tips, very smooth inside to protect the surface of the component. Serrated handles.

dpvlink 1153

Article	Type	Length [mm]
2364	Flat gripping tweezers type 127.SA	105



Precision tweezers type 00D.SA



Flat, blunt tips, strong. With a fine cut. Serrated handles.

dpvlink 1231

Article	Type	Length [mm]
2381	Precision tweezers type 00D.SA	120



Precision tweezers type AA.SA



Fine, straight tips. For different applications.

dpvlink 19472

Article	Type	Length [mm]
2346	Precision tweezers type AA.SA	127



Precision tweezers type 00.SA

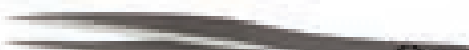

Strong, thick, flat tips, straight.

dpvlink 19474

Article	Type	Length [mm]
2347	Precision tweezers type 00.SA	123



Precision tweezers type 2.SA



Flat, sharp, fine tips.

dpvlink 19476

Article	Type	Length [mm]
2348	Precision tweezers type 2.SA	122



CK Precision ESD



The series „Precision ESD“ was especially developed for the safe handling of small components in fine applications where it is critical to prevent damage from electrostatic charge.

- Stainless steel anti-magnetic, acid- and corrosion-resistant
- ESD-safe black epoxy coating
- Manufactured with state-of-the art production methods
- Controlled piece by piece
- Wide selection, many shapes lengths and thicknesses

Precision tweezers type 5.SA ESD



Superfine tips, straight. For various applications.

ESD-safe epoxy coating.

dpvlink 19335

Article	Type	L [mm]
2341D-ESD	Precision tweezers type 5.SA ESD	110



Precision tweezers type AA.SA ESD



Fine tips, straight. For various applications.

ESD-safe epoxy coating.

dpvlink 19370			
Article	Type	L [mm]	QR
2368D-ESD	Precision tweezers type AA.SA ESD	127	

Precision tweezers type SS.SA ESD



Slim long, super-fine tips. Provides extended reach and access in confined areas.

ESD-safe epoxy coating.

dpvlink 19372			
Article	Type	L [mm]	QR
2368D-ESD	Precision tweezers type SS.SA ESD	140	

Precision tweezers type 00.SA ESD



Strong, thick, flat tips, straight.

ESD-safe epoxy coating.

dpvlink 19375			
Article	Type	L [mm]	QR
2347D-ESD	Precision tweezers type 00.SA ESD	122	

Precision tweezers type 1.SA ESD



Slim, straight, fine tips.

ESD-safe epoxy coating.

dpvlink 19377			
Article	Type	L [mm]	QR
2369D-ESD	Precision tweezers type 1.SA ESD	120	

Precision tweezers type 2.SA ESD



Flat, sharp, fine tips.

ESD-safe epoxy coating.

dpvlink 19379			
Article	Type	L [mm]	QR
2348D-ESD	Precision tweezers type 2.SA ESD	120	

Precision tweezers type 2AB.SA ESD

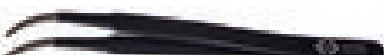

Flat, sharp tips, bent. For the handling of delicate or small components. Tip angle facilitates the equipping of PCBs.

ESD-safe epoxy coating.

dpvlink 19381			
Article	Type	L [mm]	QR
2370D-ESD	Precision tweezers type 2AB.SA ESD	117	

Precision tweezers type 3.SA ESD



Very sharp, fine tips.

ESD-safe epoxy coating.

dpvlink 19383			
Article	Type	L [mm]	QR
2379D-ESD	Precision tweezers type 3.SA ESD	120	

Precision tweezers type 3C.SA ESD

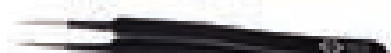

Extremely fine, sharp tips, straight. For various applications.

ESD-safe epoxy coating.

dpvlink 19470			
Article	Type	L [mm]	QR
2340D-ESD	Precision tweezers type 3C.SA ESD	110	

Precision tweezers type 4A.SA ESD

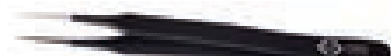

Superfine, robust tips, straight. For various applications.

ESD-safe epoxy coating.

dpvlink 19385			
Article	Type	L [mm]	QR
2388D-ESD	Precision tweezers type 4A.SA ESD	110	

Precision tweezers type 5A.SA ESD



Oblique, extremely fine tips. For better visibility during work.

ESD-safe epoxy coating.

dpvlink 19387			
Article	Type	L [mm]	QR
2389D-ESD	Precision tweezers type 5A.SA ESD	115	

Precision tweezers type 7A.SA ESD



Extremely fine tips, bent and robust.

ESD-safe epoxy coating.

dpvlink 19389			
Article	Type	L [mm]	QR
2361D-ESD	Precision tweezers type 7A.SA ESD	120	

Precision tweezers type 12.SA ESD



For positioning and soldering 1mm wide components. Tips bent by 45°.

ESD-safe epoxy coating.

dpvlink 19391			
Article	Type	L [mm]	QR
2362D-ESD	Precision tweezers type 12.SA ESD	120	

Precision tweezers type 13.SA ESD



Grooved tips for positioning and soldering 1mm wide components.

ESD-safe epoxy coating.

dpvlink 19393

Article	Type	L [mm]	QR
2363D-ESD	Precision tweezers type 13.SA ESD	120	

Placement tweezers type 2A.SA ESD



Flat, round tips, very fine polished. Straight.

ESD-safe epoxy coating.

dpvlink 19471

Article	Type	L [mm]	QR
2360D-ESD	Placement tweezers type 2A.SA ESD	123	

CK CARBOFIB



The tips of the Carbofib tweezers consist of black carbon fiber material. Significantly softer than steel, but still resistant, with their smooth surface they go easy on components with very sensitive surfaces, such as SMD, wafer or ceramic capacitors. The conductive material is suitable for ESD areas, completely antimagnetic, acid-resistant and resistant to temperatures up to 270°C.

Placement tweezers type 259CF



Fine tips made of carbon fiber.

dpvlink 1244

Article	Type	L [mm]	QR
2390	Placement tweezers type 259CF	130	

Placement tweezers type 5CF



Fine, extra slender tips made of carbon fiber.

dpvlink 1247

Article	Type	L [mm]	QR
2391	Placement tweezers type 5CF	130	

Placement tweezers type 249CF



Round tips, 2 mm wide, made of carbon fiber.

dpvlink 1249

Article	Type	L [mm]	QR
2392	Placement tweezers type 249CF	130	

CK CERAMIC



The especially light ceramic tweezers are characterized by a large number of special properties which meet also very special requirements.

Ceramic tweezers type 73 MZ SA



Straight tips made of zirconia ceramic. Smooth stainless steel handles.

dpvlink 1308

Article	Type	L [mm]	QR
2345A	Ceramic tweezers type 73 MZ SA	140	

Ideal-tek



As a Swiss manufacturer *ideal-tek* is specialized in the production of high-quality precision tweezers and pliers in the highest quality segment.

The tools of *ideal-tek* impress by an exceptional precision and fineness. Specifically satined surfaces provide a glare-free and comfortable working. Only high-quality raw materials are used.

ideal-tek has more than 30 years of experience in the application of high-tech plastics and ceramics.

ESD safety and mechanical sensitivity of the parts as well as a user-friendly handling and ergonomic finishing are ensured by a wide range of material variations, surface coatings and different designs.

Consequently, this enormous selection allows you to find the most optimal solution for your requirements.

Material descriptions and properties

Code	Material	Properties
C	Carbon steel	<ul style="list-style-type: none"> · very long service life · very sturdy · optimum hardness · resistant · highly magnetic · sensitive to corrosion (Protection only by nickel plating)
S	Tool steel, hardened	<ul style="list-style-type: none"> · stainless · fine tips available · good hardness values · magnetizable
SA	Stainless steel	<ul style="list-style-type: none"> · largely stainless · non-magnetizable (80%) · resistant against most acids and vapors · medium hardness
BR	Copper zinc alloy (brass)	<ul style="list-style-type: none"> · antimagnetic · largely resistant to corrosion by water and vapor · very good cold formability · suitable for sensitive mechanical parts

Code	Material	Properties
CF	conductive carbon fiber reinforced Carbofib (PA)	<ul style="list-style-type: none"> · ESD safe, conductive · chemical resistance · gentle on surfaces · strong and durable · surface resistance 10^2 ohm · temperature-resistant up to 190°C · continuous use temperature 130°C
CP	conductive carbon fiber reinforced PEEK	<ul style="list-style-type: none"> · ESD safe, dissipative · very hard and stiff · high resistance against aggressive chemicals · surface resistance $10^5 - 10^6$ ohm · temperature-resistant up to 300°C · continuous use temperature up to 260°C
Note: All-steel tweezers are 100% conductive. In certain circumstances they can be used in ESD areas. The decision about an application in ESD areas is up to the user.		
MZ Ceramic	Zirconia ceramic and aluminium	<ul style="list-style-type: none"> · no electromagnetic induction at high frequency · no eddy current losses · 100% electrically insulating · 100% antimagnetic · 100% antistatic · 100% stainless · extremely wear-resistant · temperature-resistant up to 700°C · extremely low thermal conductivity · resistant to acids and alkalis (except hydrofluoric acid) · extremely smooth anti-adhesive surface · tips can break in case of misuse
Note: The following coatings can be applied to all suitable tweezers. Prices on request.		
DN	PVC foam	<ul style="list-style-type: none"> · very soft and elastic · abrasion-resistant · tear-resistant · good chemical resistance · ESD safe, dissipative · In compliance with the ESD standard DIN EN 61340-5-1
DR	Nitrile	<ul style="list-style-type: none"> · very soft and elastic · high chemical resistance · ESD safe, dissipative · In compliance with ESD standard DIN EN 61340-5-1
ESD (NE)	ESD Polyester epoxy (black)	<ul style="list-style-type: none"> · ESD safe · temperature-resistant up to 150°C · In compliance with ESD standard DIN EN 61340-5-1

Plastic precision tweezers

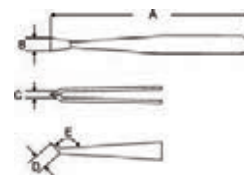

The *ideal-tek* precision plastic tweezers in three different materials for various applications. Version CF is suitable for ESD sensitive components.

Code	Material	Properties
CF	conductive carbon fiber reinforced Carbofib (PA)	<ul style="list-style-type: none"> · ESD safe, conductive · chemical resistance · gentle on surfaces · strong and durable · surface resistance 10^2 ohm · temperature-resistant up to 190°C · continuous use temperature 130°C

Plastic precision tweezers 702A



B: 2.0 mm, C: 1.0 mm; flat rounded tips, Swiss-made

[dpvlink 12463](#)

Article	Type	L [mm]
I-702A.CF	ESD plastic tweezers 702A.CF	115



Plastic precision tweezers 705



B: 0.05 mm, C: 0.6 mm; very fine, offset tips, Swiss-made

[dpvlink 11672](#)

Article	Type	L [mm]
I-705.CF	ESD plastic tweezers 705.CF	115



Plastic precision tweezers 707



B: 0.05 mm, C: 1.2 mm; fine tips, Swiss-made

[dpvlink 11564](#)

Article	Type	L [mm]
I-707.CF	ESD plastic tweezers 707.CF	115



Plastic precision tweezers 707A



B: 0.6 mm, C: 1.0 mm; fine, bent tips, Swiss-made

[dpvlink 12465](#)

Article	Type	L [mm]
I-707A.CF	ESD plastic tweezers 707A.CF	115



Precision tweezers

Plastic precision tweezers 708



B: 0.5 mm, C: 1.0 mm, D: 9.0 mm, E: 45°; fine, angled tips, Swiss-made

dpvlink 11566

Article	Type	L [mm]
I-708.CF	ESD plastic tweezers 708.CF	115



Plastic precision tweezers 709



B: 3.0 mm, C: 0.5 mm; wide tips, Swiss-made

dpvlink 11574

Article	Type	L [mm]
I-709.CF	ESD plastic tweezers 709.CF	115



Plastic precision tweezers 710



B: 8.0 mm, C: 0.5 mm; slit-shaped tips, Swiss-made

dpvlink 11568

Article	Type	L [mm]
I-710.CF	ESD plastic tweezers 710.CF	115



Plastic precision tweezers set



high-quality, content: 702A, 705, 707, 708, 709, 710, Swiss-made

dpvlink 12468

Article	Type
I-K6CF	Plastic tweezers set



ESD tweezers with plastic tips

ideal-tek has the world's largest range of precision tweezers with plastic tips and more than 20 years of experience in the application of high-tech plastics with precision tools.

Code	Material	Properties
Material of handle		
SA	Stainless steel	<ul style="list-style-type: none"> · largely stainless · non-magnetizable (80%) · resistant against most acids and vapors · medium hardness
Material of tips		
CF	<i>Tips:</i> conductive carbon fiber reinforced Carbofib <i>Handles:</i> stainless steel	<ul style="list-style-type: none"> · ESD safe, conductive · chemical resistance · gentle on surfaces · strong and durable · surface resistance 10^2 ohm · temperature-resistant up to 190°C · continuous use temperature 130°C

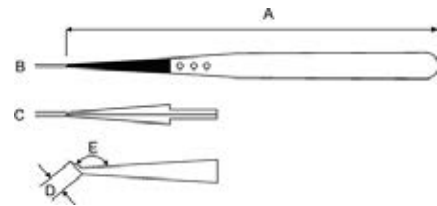

ESD tweezers with plastic tips 00



B: 1.0 mm, C: 2.0 mm; plastic tips, Swiss-made

dpvlink 11524

Article	Type	L [mm]
I-00CF.SA	ESD placement tweezers 00CF.SA	130



ESD tweezers with plastic tips 2A



B: 1.8 mm, C: 1.0 mm; plastic tips, Swiss-made

dpvlink 11850

Article	Type	L [mm]
I-2ACF.SA	ESD placement tweezers 2ACF.SA	130



ESD tweezers with plastic tips 5



B: 0.5 mm, C: 0.6 mm; plastic tips, Swiss-made

dpvlink 11970

Article	Type	L [mm]
I-5CF.SA	ESD placement tweezers 5CF.SA	130



ESD tweezers with plastic tips 248



B: 10 mm, C: 1.8 mm; plastic tips, Swiss-made

dpvlink 11814

Article	Type	L [mm]
I-248CF.SA	ESD placement tweezers 248CF.SA	130



ESD tweezers with plastic tips 249



B: 2.2 mm C: 2.2 mm; plastic tips, Swiss-made

dpvlink 11818

Article	Type	L [mm]
I-249CF.SA	ESD placement tweezers 249CF.SA	130



ESD tweezers with plastic tips 259



B: 0.6 mm, C: 1.0 mm; plastic tips, Swiss-made

dpvlink 11838

Article	Type	L [mm]
I-259CF.SA	ESD placement tweezers 259CF.SA	130



ESD tweezers with plastic tips 269



B 3.0 mm, C: 1.8 mm; plastic tips, Swiss-made

dpvlink 11844

Article	Type	L [mm]
I-269CF.SA	ESD placement tweezers 269CF.SA	130



ESD tweezers with exchangeable tips

ideal-tek has the world's largest range of precision tweezers with plastic tips and more than 20 years of experience in the application of hightech plastics for precision tools. The *ideal-tek* tips system is easy to use and of highest precision. Replacement tip kits include two tips and 3 screws.

Code	Material	Properties
Material of handle		
SA	stainless steel	<ul style="list-style-type: none"> · largely stainless · non-magnetizable (80%) · resistant against most acids and vapors · medium hardness
Material of exchangeable tips		
CF	<i>Tips:</i> conductive carbon fiber reinforced Carbofib <i>Handles:</i> stainless steel	<ul style="list-style-type: none"> · ESD safe, conductive · chemical resistance · gentle on surfaces · strong and durable · surface resistance 10^2 ohm · temperature-resistant up to 190°C · continuous use temperature 130°C
CP	<i>Tips:</i> conductive carbon fiber-reinforced PEEK <i>Handles:</i> stainless steel	<ul style="list-style-type: none"> · ESD safe, dissipative · very hard and stiff · high resistance to aggressive chemicals · surface resistance $10^5 - 10^6$ ohm · temperature-resistant up to 300°C · continuous use temperature 130°C

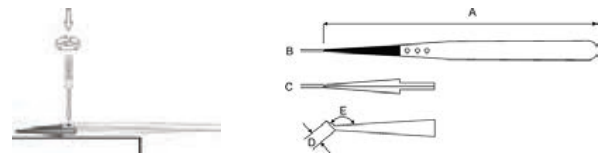

Tweezers with exchangeable tips 00



B: 1.0 mm, C: 2.0 mm; exchangeable plastic tips, Swiss-made

dpvlink 11788

Article	Type	L [mm]
I-00CFR.SA	ESD exchangeable tip tweezers 00CFR.SA	130
I-A00CF	Replacement exchangeable tips A00CF	



Tweezers with exchangeable tips 2A



B: 1.8 mm, C: 1.0 mm; exchangeable plastic tips, Swiss-made

dpvlink 11854

Article	Type	L [mm]
I-2ACFR.SA	ESD exchangeable tip tweezers 2ACFR.SA	130
I-2ACPR.SA	ESD exchangeable tip tweezers 2ACPR.SA	130
I-A2ACF	Replacement exchangeable tips A2ACF	
I-A2ACP	Replacement exchangeable tips A2ACP	



Reverse-action tweezers with exchangeable tips 2AX



B: 1.8 mm, C: 1.0 mm; exchangeable plastic tips, Swiss-made

dpvlink 11862



Article	Type	L [mm]
I-2AXCFR.SA	ESD exchangeable tip reverse-action tweezers 2AXCPR .SA	130
I-2AXCPR.SA	ESD exchangeable tip reverse-action tweezers 2AXCPR .SA	130
I-2AXSVR.SA	ESD exchangeable tip reverse-action tweezers 2AXCPR .SA	130

**** Replaceable tips like with 2A ****

Tweezers with exchangeable tips 2AB



B: 1.8 mm, C: 1.0 mm; exchangeable plastic tips, Swiss-made

dpvlink 11648



Article	Type	L [mm]
I-2ABCFR.SA	ESD exchangeable tip tweezers 2ABCFR.SA	130
I-2ABCPR.SA	ESD exchangeable tip tweezers 2ABCPR.SA	130
I-A2ABCF	Replacement exchangeable tips A2ABCF	
I-A2ABCP	Replacement exchangeable tips A2ABCP	

Tweezers with exchangeable tips 5



B: 0.5 mm, C: 0.6 mm; exchangeable plastic tips, Swiss-made

dpvlink 11972



Article	Type	L [mm]
I-5CFR.SA	ESD exchangeable tip tweezers 5CFR.SA	130
I-5CPR.SA	ESD exchangeable tip tweezers 5CPR.SA	130
I-A5CF	Replacement exchangeable tips A5CF	
I-A5CP	Replacement exchangeable tips A5CP	

Tweezers with exchangeable tips 7



B: 0.6 mm, C: 0.6 mm; exchangeable plastic tips, Swiss-made

dpvlink 12030



Article	Type	L [mm]
I-7CFR.SA	ESD exchangeable tip tweezers 7CFR.SA	130
I-7CPR.SA	ESD exchangeable tip tweezers 7CPR.SA	130
I-A7CF	Replacement exchangeable tips A7CF	
I-A7CP	Replacement exchangeable tips A7CP	

Tweezers with exchangeable tips 242



B: 1.4 mm, C: 1.2 mm; exchangeable plastic tips, Swiss-made

dpvlink 11810



Article	Type	L [mm]
I-242CFR.SA	ESD exchangeable tip tweezers 242CFR.SA	130
I-242CPR.SA	ESD exchangeable tip tweezers 242CPR.SA	130
I-A242CF	Replacement exchangeable tips A242CF	
I-A242CP	Replacement exchangeable tips A242CP	

Tweezers with exchangeable tips 246



B: 0.6 mm, C: 0.8 mm, D: 9.0 mm, E: 45°; exchangeable plastic tips, Swiss-made

dpvlink 11812



Article	Type	L [mm]
I-246CFR.SA	ESD exchangeable tip tweezers 246CFR.SA	130
I-A246CF	Replacement exchangeable tips A246CF	

Tweezers with exchangeable tips 249



B: 2.2 mm C: 2.2 mm; exchangeable plastic tips, Swiss-made

dpvlink 11820



Article	Type	L [mm]
I-249CFR.SA	ESD exchangeable tip tweezers 249CFR.SA	130
I-249CPR.SA	ESD exchangeable tip tweezers 249CPR.SA	130
I-A249CF	Replacement exchangeable tips A249CF	
I-A249CP	Replacement exchangeable tips A249CP	

Tweezers with exchangeable tips 259



B: 0.6 mm, C: 1.0 mm; exchangeable plastic tips, Swiss-made

dpvlink 11840



Article	Type	L [mm]
I-259CFR.SA	ESD exchangeable tip tweezers 259CFR.SA	130
I-259CPR.SA	ESD exchangeable tip tweezers 259CPR.SA	130
I-A259CF	Replacement exchangeable tips A259CF	
I-A259CP	Replacement exchangeable tips A259CP	

Wafer tweezers 4WFCPR.SA with exchangeable tips



A: 12 mm, B: 10.5 mm, C: 2 mm, D: 3.5 mm, E: 4.5 mm, exchangeable tips, Swiss-made

dpvlink 11676



Article	Type	L [mm]
I-4WFCPR.SA	Wafer tweezers 4WFCPR.SA	130
I-A4WFCP	ESD exchangeable plastic tips A4WFCP	

Placement tweezers

Specially designed tweezers to hold electronic components tight and safely.

Code	Material	Properties
SA	Stainless steel	<ul style="list-style-type: none"> · largely stainless · non-magnetizable (80%) · resistant against most acids and vapors · medium hardness

Placement tweezers 572.SA



for cylindrical components with different diameters, like TO-18, Swiss-made

dpvlink 11542

Article	Type	L [mm]	Ø component
I-572.SA	Placement tweezers 572.SA	145	2.5 - 5 mm
I-578.SA	Placement tweezers 578.SA	120	2 mm
I-582.SA	Placement tweezers 582.SA	120	1 mm

Ceramic tweezers

Precision exchangeable tips made of the ceramic zirconia (MZ)

Typical surface resistance $R_S = 10^{12}$ ohm, insulating.

Resistant to high temperatures of up to 1500°C. Contamination-free even at high temperatures, particularly resistant to abrasion and solder. Tweezer body made of acid-resistant, antimagnetic steel with patented adjustable exchangeable tips.

Code	Material	Properties
SA	Stainless steel	<ul style="list-style-type: none"> · largely stainless · non-magnetizable (80%) · resistant against most acids and vapors · medium hardness
MZ Ceramic	Zirconia ceramic and aluminium	<ul style="list-style-type: none"> · no electromagnetic induction at high frequency · no eddy current losses · 100% electrically insulating · 100% antimagnetic · 100% antistatic · 100% stainless · extremely wear-resistant · temperature-resistant up to 700°C · extremely low thermal conductivity · resistant to acids and alkalis (except hydrofluoric acid) · extremely smooth anti-adhesive surface · tips can break in case of misuse

Ceramic tweezers 2AMZ

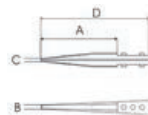

A: 35 mm, B: 2 mm C: 0.5 mm, exchangeable tips, Swiss-made

dpvlink 11612

Article	Type	L [mm]
I-2AMZ.SA	Ceramic tweezers 2AMZ.SA	130
I-A2AMZ	Exchangeable ceramic tips A2AMZ	

Ceramic tweezers 71MZ



A: 30 mm, B: 0.3 mm, C: 0.3 mm, exchangeable tips, Swiss-made

dpvlink 11600

Article	Type	L [mm]
I-71MZ.SA	Ceramic tweezers 71MZ.SA	130
I-A71MZ	Exchangeable ceramic tips A71MZ	

Ceramic tweezers 72MZ



A: 30 mm, B: 0.3 mm, C: 0.7 mm, exchangeable tips, Swiss-made

dpvlink 11602

Article	Type	L [mm]
I-72MZ.SA	Ceramic tweezers 72MZ.SA	135
I-A72MZ	Exchangeable ceramic tips A72MZ	

Ceramic tweezers 73MZ

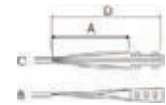

A: 35 mm, B: 0.3 mm, C: 1.0 mm, exchangeable tips, Swiss-made

dpvlink 11604

Article	Type	L [mm]
I-73MZ.SA	Ceramic tweezers 73MZ.SA	140
I-A73MZ	Exchangeable ceramic tips A73MZ	

Universal tweezers

Tweezers available in different materials and designs

Code	Material	Properties
SA	Stainless steel	<ul style="list-style-type: none"> · largely stainless · non-magnetizable (80%) · resistant against most acids and vapors · medium hardness

Universal tweezers AA



straight and fine tips, Swiss-made

dpvlink 11758

Article	Type	L [mm]
I-AA.SA	Universal tweezers AA.SA	130

Universal tweezers MM



robust and fine tips, Swiss-made

dpvlink 12052

Article	Type	L [mm]
I-MM.SA	Universal tweezers MM.SA	130

Precision tweezers

Universal tweezers 119



fine tips, serrated tips and handles, Swiss-made

dpvlink 11498

Article	Type	L [mm]
I-119.SA	Universal tweezers 119.SA	150



Universal tweezers 120A



fine tips, strongly serrated tips and handles, Swiss-made

dpvlink 11502

Article	Type	L [mm]
I-120A.SA	Universal tweezers 120A.SA	110



Universal tweezers 121



very sturdy, blunt serrated tips and handles, Swiss-made

dpvlink 11504

Article	Type	L [mm]
I-121.SA	Universal tweezers 121.SA	160



Universal tweezers 122.SA



fine and angled tips, serrated handles and tips, Swiss-made

dpvlink 11508

Article	Type	L [mm]
I-122.SA	Universal tweezers 122.SA	150



Universal tweezers 124



fine, angled and strongly serrated tips and handles, Swiss-made

dpvlink 11512

Article	Type	L [mm]
I-124.SA	Universal tweezers 124.SA	150



Universal tweezers 649



sturdy, fine and angled tips, alignment pin, serrated tips and handles; Swiss-made

dpvlink 11562

Article	Type	L [mm]
I-649.SA	Universal tweezers 649.SA	150



Precision tweezers

Handcrafted precision tweezers for a perfect symmetry and balance, with polished edges and glare-free satin finish.

Precision tweezers 0



flat, fine tips, Swiss-made

dpvlink 12102

Article	Type	L [mm]
I-0.SA	Precision tweezers 0.SA	120



Precision tweezers 00



sturdy, flat, thick tips, Swiss-made

dpvlink 12098

Article	Type	L [mm]
I-00.SA	Precision tweezers 00.SA	120



Precision tweezers 000



sturdy, flat, rounded tips, fine; Swiss-made

dpvlink 12104

Article	Type	L [mm]
I-000.SA	Precision tweezers 000.SA	120



Precision tweezers 00D



as 00, with serrated tips and handles, Swiss-made

dpvlink 12106

Article	Type	L [mm]
I-00D.SA	Precision tweezers 00D.SA	120



Precision tweezers 0C9



flat and fine tips, short; Swiss-made

dpvlink 12110

Article	Type	L [mm]
I-0C9.SA	Precision tweezers 0C9.SA	90



Precision tweezers 1



sturdy, fine and straight tips, Swiss-made

dpvlink 12112

Article	Type	L [mm]
I-1.SA	Precision tweezers 1.SA	120



Precision tweezers 2



flat, sharp and fine tips, Swiss-made

dpvlink 12084

Article	Type	L [mm]
I-2.SA	Precision tweezers 2.SA	120



Precision tweezers 2A



flat, precise and round tips, Swiss-made

dpvlink 12090

Article	Type	L [mm]
I-2A.SA	Precision tweezers 2A.SA	120



Precision tweezers 2AB



like 2A, with bent tips, Swiss-made

dpvlink 12118

Article	Type	L [mm]
I-2AB.SA	Precision tweezers 2AB.SA	120



Precision tweezers 2AR



flat, rounded and fine tips, Swiss-made

dpvlink 11418

Article	Type	L [mm]
I-2AR.SA	Precision tweezers 2AR.SA	120



Precision tweezers 3



very sharp, fine tips, Swiss-made

dpvlink 11700

Article	Type	L [mm]
I-3.SA	Precision tweezers 3.SA	120



Precision tweezers 3C



as 3, short, Swiss-made

dpvlink 11704

Article	Type	L [mm]
I-3C.SA	Precision tweezers 3C.SA	110



Precision tweezers 4



extra fine tips, Swiss-made

dpvlink 11710

Article	Type	L [mm]
I-4.SA	Precision tweezers 4.SA	110
I-4.S	Precision tweezers 4.S	110



Precision tweezers 4A



as 4, but sturdier, Swiss-made

dpvlink 12128

Article	Type	L [mm]
I-4A.SA	Precision tweezers 4A.SA	110



Precision tweezers 5



extra fine tips, high-quality version, Swiss-made

dpvlink 11718

Article	Type	L [mm]
I-5.SA	Precision tweezers 5.SA	110
I-5.S	Precision tweezers 5.S	110



Precision tweezers 5A



extra fine tips, high-quality version, Swiss-made

dpvlink 11726

Article	Type	L [mm]
I-5A.SA	Precision tweezers 5A.SA	115



Precision tweezers 5B



as 5, bent tips, Swiss-made

dpvlink 12136

Article	Type	L [mm]
I-5B.SA	Precision tweezers 5B.SA	110



Precision tweezers 6



fine tips, flat angled; Swiss-made

dpvlink 11734

Article	Type	L [mm]
I-6.SA	Precision tweezers 6.SA	115



Precision tweezers

Precision tweezers 7



very fine tips, bent, Swiss-made.

[dpvlink 11742](#)

Article	Type	L [mm]
I-7.SA	Precision tweezers 7.SA	115



Precision tweezers 7A



as 7, sturdy, Swiss-made

[dpvlink 12154](#)

Article	Type	L [mm]
I-7A.SA	Precision tweezers 7A.SA	115



Precision tweezers 7B



as 7, with serrated tips, Swiss-made

[dpvlink 12158](#)

Article	Type	L [mm]
I-7B.SA	Precision tweezers 7B.SA	115



Precision tweezers 10G



fine serrated tips and handles, Swiss-made

[dpvlink 11444](#)

Article	Type	L [mm]
I-10G.SA	Precision tweezers 10G.SA	110



Precision tweezers 51S



as 5A, bent tips for maximum visibility, Swiss-made

[dpvlink 11458](#)

Article	Type	L [mm]
I-51S.SA	Precision tweezers 51S.SA	115



Precision tweezers AM



brass precision tweezers, anti-sparking, Swiss-made

[dpvlink 11682](#)

Article	Type	L [mm]
I-AM.BR	Precision tweezers AM.BR	125



Precision tweezers F



as 2A, flat and angular tips, Swiss-made

[dpvlink 11764](#)

Article	Type	L [mm]
I-F.SA	Precision tweezers F.SA	120



Precision tweezers set K5HP



Content: 00, 2A, 3C, 5, 7
high quality with hard foam insert, Swiss-made

[dpvlink 11766](#)

Article	Ausführung
I-K5HP.SA	Precision tweezers set K5HP.SA



Carbofib soft tweezers

The soft plastic tips facilitate the handling of sensitive components. *ideal-tek* has the world's largest range of precision tweezers with plastic tips and more than 20 years of experience in the application of high-tech plastics for precision tools.

Code letter	Material	Properties
Material of handle		
SA	stainless steel	<ul style="list-style-type: none"> · stainless · antimagnetic · resistant to most acids and vapors · medium hardness
Material of tips		
CF	<i>Tips:</i> conductive carbon fiber reinforced Carbofib <i>Handles:</i> stainless steel	<ul style="list-style-type: none"> · ESD safe, conductive · chemical resistance · gentle on surfaces · strong and durable · surface resistance 10² ohm · temperature-resistant up to 190°C · continuous use temperature 130°C

Carbofib soft tweezers 251.SA



[dpvlink 11526](#)

Article	Type	L [mm]
I-251.SA	Carbofib soft tweezers 251.SA	110



Carbofib soft tweezers 252.SA



Swiss-made

[dpvlink 11696](#)

Article	Type	L [mm]
I-252.SA	Carbofib soft tweezers 252.SA	110



High-precision tweezers

Handcrafted high-precision tweezers for a perfect symmetry and balance with polished edges and glare-free satin finish. All high-precision tweezers are available in different materials.

Antimagnetic, acid-resistant steel (SA), INOX steel (S), nickel-chrome-molybdenum steel (NC), titanium (TI), bronze (BR)
Surface coating of epoxy (EP only handles), ESD epoxy (NE only handles), teflon (TE whole tweezers)

Code	Material	Properties
SA	Stainless steel	<ul style="list-style-type: none"> · largely stainless · non-magnetizable (80%) · resistant against most acids and vapors · medium hardness

High-precision reverse-action tweezers 5AX.SA



dpvlink 11594

Article	Type	L [mm]
I-5AX.SA	High-precision reverse-action tweezers 5AX.SA	115

High-precision tweezers M-3



sharp, fine tips, Swiss-made

dpvlink 11670

Article	Type	L [mm]
I-M-3.SA	High-precision tweezers M-3.SA	70

High-precision tweezers M-4



very fine tips, Swiss-made

dpvlink 12046

Article	Type	L [mm]
I-M-4.SA	High-precision tweezers M-4.SA	80

Thin precision tweezers

Extra long and slender precision tweezers for various applications.

Code	Material	Properties
SA	Stainless steel	<ul style="list-style-type: none"> · largely stainless · non-magnetizable (80%) · resistant against most acids and vapors · medium hardness

Thin precision tweezers, 65A



very fine, angled tips, Swiss-made

dpvlink 11738

Article	Type	L [mm]
I-65A.SA	Thin precision tweezers, 65A.SA	140

Thin precision tweezers, SS



extra fine tips, Swiss-made

dpvlink 11776

Article	Type	L [mm]
I-SS.SA	Thin precision tweezers, SS.SA	140

ESD Precision tweezers

Handcrafted precision tweezers for a perfect symmetry and balance with antistatic coating.

Code	Material	Properties
SA	Stainless steel	<ul style="list-style-type: none"> · largely stainless · non-magnetizable (80%) · resistant against most acids and vapors · medium hardness

Universal tweezers AA ESD



straight, fine tips, antistatic coating, Swiss-made

dpvlink 16148

Article	Type	L [mm]
I-AA.SA.ESD	ESD universal tweezers AA.SA.ESD	130

Precision tweezers 00 ESD



sturdy, flat, thick tips, antistatic coating, Swiss-made

dpvlink 16149

Article	Type	L [mm]
I-00.SA.ESD	ESD Precision tweezers 00.SA.ESD	120

Precision tweezers 1 ESD



sturdy, fine and straight tips, antistatic coating, Swiss-made

dpvlink 16150

Article	Type	L [mm]
I-1.SA.ESD	ESD Precision tweezers 1.SA.ESD	120

Precision tweezers 2 ESD



flat, sharp and fine tips, antistatic coating, Swiss-made

dpvlink 16151

Article	Type	L [mm]
I-2.SA.ESD	Precision tweezers 2.SA.ESD	120

Precision tweezers

Precision tweezers 2A ESD



flat, precise and rounded tips, antistatic coating, Swiss-made

dpvlink 16152

Article	Type	L [mm]
I-2A.SA.ESD	ESD Precision tweezers 2A.SA.ESD	120



Precision tweezers 3 ESD



very sharp, fine tips, antistatic coating, Swiss-made

dpvlink 16153

Article	Type	L [mm]
I-3.SA.ESD	ESD Precision tweezers 3.SA.ESD	120



Precision tweezers 3C ESD



very sharp, fine tips, antistatic coating, short, Swiss-made

dpvlink 16154

Article	Type	L [mm]
I-3C.SA.ESD	ESD Precision tweezers 3C.SA.ESD	110



Precision tweezers 4 ESD



extra fine tips, antistatic coating, Swiss-made

dpvlink 16155

Article	Type	L [mm]
I-4.SA.ESD	ESD Precision tweezers 4.SA.ESD	110



Precision tweezers 5 ESD



extra fine tips, antistatic coating, Swiss-made

dpvlink 16156

Article	Type	L [mm]
I-5.SA.ESD	ESD Precision tweezers 5.SA.ESD	110



Precision tweezers 5A ESD



extra fine tips, antistatic coating, Swiss-made

dpvlink 16157

Article	Type	L [mm]
I-5A.SA.ESD	ESD Precision tweezers 5A.SA.ESD	115



Precision tweezers 7 ESD



very fine tips, bent, antistatic coating, Swiss-made

dpvlink 16158

Article	Type	L [mm]
I-7.SA.ESD	ESD Precision tweezers 7.SA.ESD	115



Thin precision tweezers 65A ESD



very fine, angled tips, antistatic coating, Swiss-made

dpvlink 16159

Article	Type	L [mm]
I-65A.SA.ESD	Thin ESD Precision tweezers 65A.SA.ESD	140



Ergonomic precision tweezers

Antimagnetic precision tweezers with ergonomic, antistatic (ESD) handle for a comfortable working. (DR) blue conductive nitrile rubber, (DN) black conductive PVC foam

Code	Material	Properties
Material of handle		
DN	PVC foam	<ul style="list-style-type: none"> · very soft and elastic · abrasion-resistant · tear-resistant · good chemical resistance · ESD safe, dissipative · In compliance with the ESD standard DIN EN 61340-5-1
DR	Nitrile	<ul style="list-style-type: none"> · very soft and elastic · high chemical resistance · ESD safe, dissipative · In compliance with ESD standard DIN EN 61340-5-1
Material of tips		
SA	stainless steel	<ul style="list-style-type: none"> · largely stainless · non-magnetizable (80%) · resistant against most acids and vapors · medium hardness

Ergonomic tweezers 00.SA.DR /.DN



ESD, dissipative, thick, flat tips, with ergonomic handles, Swiss-made

dpvlink 12475

Article	Type	L [mm]
I-00.SA.DN	Ergonomic precision tweezers 00.SA.DN	120
I-00.SA.DR	Ergonomic precision tweezers 00.SA.DR	120



Ergonomic tweezers 2A.SA.DR/.DN



ESD, dissipative, flat, precise and rounded tips, ergonomic handles, Swiss-made

dpvlink 12477

Article	Type	L [mm]
I-2A.SA.DN	Ergonomic precision tweezers 2A.SA.DN	120
I-2A.SA.DR	Ergonomic precision tweezers 2A.SA.DR	120



Ergonomic tweezers 3.SA.DR /.DN



ESD, dissipative, very sharp tips, high-quality version, with ergonomic handles, Swiss-made

dpvlink 12479

Article	Type	L [mm]
I-3.SA.DR	Ergonomic precision tweezers 3.SA.DR	120
I-3.SA.DN	Ergonomic precision tweezers 3.SA.DN	120



Ergonomic tweezers 3C.SA.DR/.DN



ESD, dissipative, very sharp tips, high-quality version, with ergonomic handles, Swiss-made

dpvlink 12481

Article	Type	L [mm]
I-3C.SA.DR	Ergonomic precision tweezers 3C.SA.DR	110
I-3C.SA.DN	Ergonomic precision tweezers 3C.SA.DN	110

Ergonomic tweezers 5.SA.DR/.DN



ESD, dissipative, extra fine tips, with ergonomic handles, Swiss-made

dpvlink 12483

Article	Type	L [mm]
I-5.SA.DR	Ergonomic precision tweezers 5.SA.DR	115
I-5.SA.DN	Ergonomic precision tweezers 5.SA.DN	115

Ergonomic tweezers 7.SA.DR/.DN



ESD, dissipative, fine, bent tips, with ergonomic handles, Swiss-made

dpvlink 12485

Article	Type	L [mm]
I-7.SA.DR	Ergonomic precision tweezers 7.SA.DR	115
I-7.SA.DN	Ergonomic precision tweezers 7.SA.DN	115

Ergonomic cutting tweezers 15AGW.C.DN



ESD, dissipative, with ergonomic handles, Swiss-made

dpvlink 12487

Article	Type	L [mm]
I-15AGW.C.DN	Ergonomic cutting tweezers 15AGW.C.DN	120

Ergonomic tweezers AA.SA.DR /.DN



ESD, dissipative, precision tips, with ergonomic handles, Swiss-made

dpvlink 12489

Article	Type	L [mm]
I-AA.SA.DN	Ergonomic precision tweezers AA.SA.DN	130

SMD tweezers ESD

SMD tweezers facilitate a simple handling of the smallest SMD components. Various tip shapes and angles are available for the different component types and applications. The ergonomic shape allows a comfortable working.

Code	Material	Properties
SA	Stainless steel	<ul style="list-style-type: none"> · largely stainless · non-magnetizable (80%) · resistant against most acids and vapors · medium hardness

SMD tweezers SM103.SA ESD



for gripping and positioning components in the SOT case, bent by 45°, antistatic coating, Swiss-made

dpvlink 16161

Article	Type	L [mm]
I-SM103.SA.ESD	SMD tweezers SM103.SA.ESD	115

SMD tweezers SM104.SA ESD



for a lateral gripping and positioning of components in the SOT case, antistatic coating, Swiss-made

dpvlink 16162

Article	Type	L [mm]
I-SM104.SA.ESD	SMD tweezers SM104.SA.ESD	120

SMD tweezers SM108.SA ESD



for positioning and soldering 1 mm wide components, tips with recess for a safe hold, antistatic coating, Swiss-made

dpvlink 16163

Article	Type	L [mm]
I-SM108.SA.ESD	SMD tweezers SM108.SA.ESD	120

Precision cutting tweezers

Precision cutting tweezers with hardened tips, suitable for a precise cutting of thin wires and components.

Code	Material	Properties
S	Tool steel, hardened	<ul style="list-style-type: none"> · stainless · fine tips available · good hardness values · magnetizable
C	Carbon steel	<ul style="list-style-type: none"> · very long service life · very sturdy · optimum hardness · resistant · highly magnetic · sensitive to corrosion (Protection only by nickel plating)

Cutting tweezers 152.S



Precision miniature cutting tweezers, cutting surface, Swiss-made

dpvlink 11804

Article	Type	L [mm]
I-152.S	Cutting tweezers 152.S	98



Cutting tweezers 15A.C



for soft copper, gold, silver or magnetic wires, Swiss-made

dpvlink 11446

Article	Type	L [mm]
I-15A.C	Cutting tweezers 15A.(C)	120



Cutting tweezers 15AGW.C



for soft copper, gold, silver or magnetic wires, Swiss-made

dpvlink 11628

Article	Type	L [mm]
I-15AGW.C	Cutting tweezers 15AGW.C	120



Reverse-action tweezers

Reverse-action tweezers facilitates the comfortable handling of electronic components, in particular in soldering. Straight or bent versions (suffix B), in different lengths. Available in stainless, acid-resistant, antimagnetic steel (SA) or nickel-plated (NP).

Code	Material	Properties
SA	Stainless steel	<ul style="list-style-type: none"> · largely stainless · non-magnetizable (80%) · resistant against most acids and vapors · medium hardness

Reverse-action tweezers 29.SA



Desoldering tweezers, strongly blunted, serrated handles, Swiss-made

dpvlink 11848

Article	Type	L [mm]
I-29.SA	Reverse-action tweezers 29.SA	165



SMD tweezers

SMD tweezers facilitate a simple handling of very small SMD components. Different tip shapes and angles are available for various component types and applications. The glare-free satined surface and the ergonomic design allow a comfortable work.

Special versions are available on request. The models can also be delivered as reverse-action tweezers.

Code	Material	Properties
SA	Stainless steel	<ul style="list-style-type: none"> · largely stainless · non-magnetizable (80%) · resistant against most acids and vapors · medium hardness

SMD reverse-action tweezers SM100.SA



self-clamping, for the processing of PCBs with SMDs, Swiss-made

dpvlink 11462

Article	Type	L [mm]
I-SM100.SA	SMD reverse-action tweezers SM100.SA	115



SMD tweezers SM103.SA



for gripping and positioning components in the SOT case, bent by 45°, Swiss-made

dpvlink 11468

Article	Type	L [mm]
I-SM103.SA	SMD tweezers SM103.SA	115



SMD tweezers SM107.SA



for positioning all flat components, angled by 60°, Swiss-made

[dpvlink 11476](#)



Article	Type	L [mm]
I-SM107.SA	SMD tweezers SM107.SA	120

SMD tweezers SM110.SA



for positioning monolithic chip capacitors, tips with recesses, Swiss-made

[dpvlink 11482](#)



Article	Type	L [mm]
I-SM110.SA	SMD tweezers SM110.SA	120

SMD tweezers SM111.SA



for positioning 5 mm monolithic chip capacitors, tips with flat base recess. Swiss-made

[dpvlink 11484](#)



Article	Type	L [mm]
I-SM111.SA	SMD tweezers SM111.SA	120

SMD tweezers SM115.SA



tips with recesses, angled by 30°, for holding and positioning cylindrical components, Swiss-made

[dpvlink 11492](#)



Article	Type	L [mm]
I-SM115.SA	SMD tweezers SM115.SA	120

SMD tweezers SM116.SA



straight tips with recesses, for a vertical positioning of cylindrical components, Swiss-made

[dpvlink 11494](#)



Article	Type	L [mm]
I-SM116.SA	SMD tweezers SM116.SA	120

SMD tweezers SM117.SA



for positioning components in the SOT case, Swiss-made

[dpvlink 11496](#)



Article	Type	L [mm]
I-SM117.SA	SMD tweezers SM117.SA	120

Erem Precision tweezers

Erem Erem tweezers are high precision tools of constantly high quality. Precisely manufactured symmetrical tips combined with a free movement and a perfect balance turn it into an excellent tool.

The most common types are available in an inexpensive version (SL). The type number is not only printed on, but stamped in all Erem tweezers.

Precision tweezers AASA

Erem

Professional tweezers with fine, but very sturdy tips



[dpvlink 1431](#)



Article	Type	L [mm]
AASA	Precision tweezers	125
AASA-SL	Precision tweezers, standard	125

Precision tweezers ACSA

Erem

Special stainless steel, non-magnetic, with serrated finger grips



[dpvlink 11230](#)



Article	Type	L [mm]
ACSA	Precision tweezers	108

Precision tweezers OOSA

Erem

Professional tweezers, flat inside of the tips, for general working and equipping



[dpvlink 1434](#)



Article	Type	L [mm]
OOSA	Precision tweezers	120
OOSA-SL	Precision tweezers, standard	120

Precision tweezers OODSA

Erem

Precision tweezers with serrated finger grips and inside-serrated tips, special stainless steel, non-magnetic



[dpvlink 11232](#)



Article	Type	L [mm]
OODSA	Precision tweezers	120

Precision tweezers 2SA

Erem®



Professional tweezers with medium-fine tips, inexpensive standard version

dpvlink 1326



Article	Type	L [mm]
2SA	Precision tweezers	115
2SA-SL	Precision tweezers, standard	115

Precision tweezers 2SASA

Erem®



Professional tweezers, flat, rounded tips

dpvlink 1342



Article	Type	L [mm]
2SASA	Precision tweezers	120
2SASA-SL	Precision tweezers, standard	120

Precision tweezers 3CSA

Erem®



Professional tweezers for the microelectronics

dpvlink 1351



Article	Type	L [mm]
3CSA	Precision tweezers	110
3CSA-SL	Precision tweezers, standard	110

Precision tweezers 5SA

Erem®



Professional tweezers with very fine tips, for the handling of fine wires and miniature parts

dpvlink 1358



Article	Type	L [mm]
5SA	Precision tweezers	110
5SA-SL	Precision tweezers, standard	110

Precision tweezers 7SA

Erem®



Professional tweezers with bent, fine tips, recessed. Good handling in the smallest spaces.

dpvlink 6895



Article	Type	L [mm]
7SA	Precision tweezers	120
7SA-SL	Precision tweezers, standard	120

Precision tweezers 5ASA

Erem®



Professional tweezers with very fine tips, for the handling of fine wires and chip components

dpvlink 1361



Article	Type	L [mm]
5ASA	Precision tweezers	115
5ASA-SL	Precision tweezers, standard	115

Precision tweezers 5CSA

Erem®



Tweezers with bent tips for a better visibility under the microscope, angle 30°

dpvlink 1370



Article	Type	L [mm]
5CSA	Precision tweezers 5CSA	115

Precision tweezers 51SA

Erem®



Professional tweezers with very fine tips, angled by 30°

dpvlink 1367



Article	Type	L [mm]
51SA	Precision tweezers	115
51SA-SL	Precision tweezers, standard	115

Precision tweezers 249CER

Erem®



Ceramic tips, heat-resistant up to 900°C, nonmagnetic, insulator

dpvlink 11228



Article	Type	L [mm]
249CER	Precision tweezers	130

SMD tweezers 102ACA

Erem®



For a perfect handling of chips or miniature components, no fatigue due to a bent head, for equipping SMD PCBs or ceramic substrates, blunt edges

dpvlink 4753



Article	Type	L [mm]
102ACA	SMD tweezers	115

SMD tweezers 102ACAX

Erem®



With reverse clamping action for a perfect handling of chips or miniature components, no fatigue due to a bent head, for equipping SMD PCBs or ceramic substrates, blunt edges

dpvlink 7690



Article	Type	L [mm]
102ACAX	SMD tweezers	115

SMD tweezers 103ACA

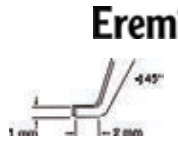

For a perfect handling of chips or miniature components, no fatigue due to a bent head, for equipping SMD PCBs or ceramic substrates, blunt edges, bent tips

dpvlink 4756

Article	Type	L [mm]
103ACA	SMD tweezers	115

Erem®

SMD tweezers 150SAD



SMD tweezers with round tips Ø 1.5 - 3 mm

dpvlink 7692

Article	Type	L [mm]
150SAD	SMD tweezers	120

Erem®

SMD tweezers 150SA



SMD tweezers with round tips Ø 1.5 - 3 mm

dpvlink 7694

Article	Type	L [mm]
150SA	SMD tweezers	120

Erem®

SMD tweezers 151SA



SMD tweezers with round tips Ø 3-6 mm

dpvlink 7696

Article	Type	L [mm]
151SA	SMD tweezers	120

Erem®

SMD tweezers 32BSA



For cylindrical miniature components Ø 5 mm, angled by 45°

dpvlink 7698

Article	Type	L [mm]
32BSA	SMD tweezers	115

Erem®

SMD tweezers 32BSA20



For cylindrical miniature components, with round tips Ø 2 or 2.5 mm, angled by 45°

dpvlink 7700

Article	Type	L [mm]
32BSA20	SMD tweezers, tips Ø 2.0 mm	115
32BSA25	SMD tweezers, Ø 2.5 mm	115

Erem®

SMD tweezers 150SAMB



For very small cylindrical components Ø 1.2 - 2.5 mm, angled by 40°

dpvlink 4758

Article	Type	L [mm]
150SAMB	SMD tweezers	115

Erem®

SMD tweezers 150SAMF



For cylindrical miniature components Ø 1.2 - 2.5 mm

dpvlink 4761

Article	Type	L [mm]
150SAMF	SMD tweezers	115

Erem®

High-precision gripping tweezers 39SA



Tweezers to hold wires and round, cylindrical components, round tips with Ø 0.3 or 0.4 mm

dpvlink 4512

Article	Type	L [mm]
39SA	High-precision gripping tweezers, tips Ø 0.3 mm	110
40SA	High-precision gripping tweezers, tips Ø 0.4 mm	110

Erem®

Cutting tweezers 15AGW



Tweezers with oblique head, long-lasting, for soft wires up to Ø 0.25 mm

dpvlink 4531

Article	Type	L [mm]
15AGW	Cutting tweezers	115

Erem®

Precision tweezers 249SA



Synthetic tips (PPS), heat-resistant up to 250°C, resistant to acids and molten solder (several seconds), water-repellent, ESD safe, outside serrated

dpvlink 1372

Article	Type	L [mm]
249SA	Precision tweezers	120

Erem® ⚠

Precision tweezers 258SA



as version 249 SA, but fine, synthetic tips (PPS), heat-resistant up to 250°C

dpvlink 1429

Article	Type	L [mm]
258SA	Precision tweezers	120

Erem® ⚠

Precision tweezers

Ergonomic precision tweezers E00SA



Professional tweezers, flat inside of the tips and ergonomic handles, for general working and equipping. ESD safe.

dpvlink 7647

Article	Type	L [mm]
E00SA	Ergonomic precision tweezers E00SA	120



Ergonomic precision tweezers E00DSA



Professional tweezers with serrated inside of the tips and ergonomic handles, for general working and equipping. ESD safe.

dpvlink 9706

Article	Type	L [mm]
E00DSA	Ergonomic precision tweezers E00DSA	120



Ergonomic precision tweezers E5SA



Professional tweezers with very fine tips and ergonomic handles, for handling fine wires and miniature components. ESD safe.

dpvlink 7643

Article	Type	L [mm]
E5SA	Ergonomic precision tweezers E5SA	120



Ergonomic precision tweezers E2ASA



Professional tweezers, flat, rounded tips and ergonomic handles. ESD safe.

dpvlink 7651

Article	Type	L [mm]
E2ASA	Ergonomic precision tweezers E2ASA	120



Ergonomic precision tweezers E7SA



Professional tweezers with bent, fine, recessed tips and ergonomic handles. Good handling in the smallest spaces. ESD safe.

dpvlink 7649

Article	Type	L [mm]
E7SA	Ergonomic precision tweezers E7SA	120



Ergonomic precision tweezers E3CSA



Professional tweezers with ergonomic handles for the microelectronics. ESD safe.

dpvlink 7645

Article	Type	L [mm]
E3CSA	Ergonomic precision tweezers E3CSA	120



Ergonomic cutting tweezers E15AGW



Professional cutting tweezers with ergonomic handles for micro-electronics. ESD safe

dpvlink 9708

Article	Type	L [mm]
E15AGW	Ergonomic cutting tweezers E15AGW	120



Kit for SMD works



6-piece set in a black plastic case with foam insert.

Consisting of:

- Precision tweezers 51SA
- SMD tweezers 102ACA
- SMD tweezers 103ACA
- SMD tweezers 150SAMB
- SMD tweezers 150SAMF
- Diagonal cutting pliers 670EP

dpvlink 6978

Article	Ausführung
3900KC	Kit for SMD works



Erem Tweezers Prime Selection



consisting of:

- precision tweezers 3SA
- precision tweezers 2ASA
- precision tweezers 7SA

dpvlink 10768

Article	Ausführung
3300TPS	Erem Tweezers Prime Selection



Erem SMD tweezers - Universal



consisting of:

- SMD precision tweezers 103ACA
- SMD precision tweezers 150SAMF
- SMD precision tweezers 102ACAX
- precision tweezers 7SASMD

dpvlink 10770

Article	Ausführung
3400TSMU	Erem tweezers - Universal



Erem Premium tweezers



consisting of:

- precision tweezers 3SA
- precision tweezers 2ASA
- precision tweezers 7SA
- SMD precision tweezers 102ACA
- cutting tweezers 15AGW

dpvlink 10771

Article	Ausführung
3500TP	Erem Premium tweezers



Piergiacomini



PIERGIACOMINI ESD tweezers - quality in any type

- dissipative due to ESD coating
- many tweezers in different materials
- large product range allows you to find the right tweezers for your application



ESD tweezers 0 SA

with fine tips. With ESD coating

dpvlink 17613			QR
Article	Type	L [mm]	
P-0SA.ESD	Tweezers 0 SA	120	

ESD tweezers 00 SA

with flat, large tips for universal applications. With ESD coating

dpvlink 17615			QR
Article	Type	L [mm]	
P-00SA.ESD	Tweezers 00 SA	120	

ESD tweezers 00D SA

with flat, large tips for universal applications. Handles outside and tips inside serrated. With ESD coating.

dpvlink 17617			QR
Article	Type	L [mm]	
P-00DSA.ESD	Tweezers 00D SA	120	

ESD tweezers 2A SA

with rounded, flat tips for general applications. With ESD coating.

dpvlink 17619			QR
Article	Type	L [mm]	
P-2ASA.ESD	Tweezers 2A SA	120	

ESD tweezers AA SA

with strong gripping effect. With ESD coating.

dpvlink 17621			QR
Article	Type	L [mm]	
P-AASA.ESD	Tweezers AA SA	130	

ESD tweezers 1 SA

with robust, thin tips for general applications. With ESD coating.

dpvlink 17623			QR
Article	Type	L [mm]	
P-1SA.ESD	Tweezers 1 SA	120	

ESD tweezers 2 SA

with sharp, robust tips for general applications. With ESD coating.

dpvlink 17625			QR
Article	Type	L [mm]	
P-2SA.ESD	Tweezers 2 SA	120	

ESD tweezers 3 SA

with sharp, thin tips for applications in microelectronics. With ESD coating.

dpvlink 17627			QR
Article	Type	L [mm]	
P-3SA.ESD	Tweezers 3 SA	120	

ESD tweezers 3C SA

with sharp, thin tips for applications in microelectronics, short version. With ESD coating.

dpvlink 17629			QR
Article	Type	L [mm]	
P-3CSA.ESD	Tweezers 3C SA	110	

ESD tweezers 7 SA

with very fine, angled tips for an easier gripping in working areas that are difficult to reach. With ESD coating.

dpvlink 17633			QR
Article	Type	L [mm]	
P-7SA.ESD	Tweezers type 7 SA	120	

ESD tweezers 7A SA

with very fine, flat and angled tips for an easier gripping in working areas that are difficult to reach. With ESD coating

dpvlink 17635			QR
Article	Type	L [mm]	
P-7ASA.ESD	Tweezers 7A SA	120	

Tweezers 0 SA

with fine tips

dpvlink 1776			QR
Article	Type	L [mm]	
P-0SA	Tweezers 0 SA	120	

Tweezers 00 SA

with flat, large tips for universal applications.

dpvlink 1772			QR
Article	Type	L [mm]	
P-00SA	Tweezers 00 SA	120	

Tweezers 00B SA

outside serrated, with flat, large tips for universal applications.



dpvlink 7766			
Article	Type	L [mm]	QR
P-00BSA	Tweezers 00B SA	120	

Tweezers 00C SA

with flat, large tips for universal applications, short handles



dpvlink 7768			
Article	Type	L [mm]	QR
P-00CSA	Tweezers 00C SA	105	

Tweezers 00D SA

flat, large tips for universal applications. Handles outside and tips inside serrated



dpvlink 7770			
Article	Type	L [mm]	QR
P-00DSA	Tweezers 00D SA	120	

Tweezers 0A SA

with very fine tips for watch repairs.



dpvlink 7774			
Article	Type	L [mm]	QR
P-0ASA	Tweezers 0A SA	120	

Tweezers 1 SA

with sturdy, thin tips for general applications.



dpvlink 7806			
Article	Type	L [mm]	QR
P-1SA	Tweezers 1 SA	120	

Tweezers 2 SA

with sharp, sturdy tips for general applications.



dpvlink 7818			
Article	Type	L [mm]	QR
P-2SA	Tweezers 2 SA	120	

Tweezers 2A SA

with rounded, flat tips for general applications.



dpvlink 7816			
Article	Type	L [mm]	QR
P-2ASA	Tweezers 2A SA	120	

Tweezers 2AB SA

with rounded, flat and bent tips for universal applications.



dpvlink 7814			
Article	Type	L [mm]	QR
P-2ABSA	Tweezers 2AB SA	120	

Tweezers 3 SA

with sharp, thin tips for applications in the microelectronics.



dpvlink 7826			
Article	Type	L [mm]	QR
P-3SA	Tweezers 3 SA	120	

Tweezers 3C SA

with sharp, thin tips for applications in the microelectronics, short version



dpvlink 7824			
Article	Type	L [mm]	QR
P-3CSA	Tweezers 3C SA	110	

Tweezers 4 SA

with very fine, sharp tips.



dpvlink 7830			
Article	Type	L [mm]	QR
P-4SA	Tweezers 4 SA	110	

Tweezers 4A SA

with sharp, sturdy tips



dpvlink 7828			
Article	Type	L [mm]	QR
P-4ASA	Tweezers 4A SA	110	

Tweezers 5 SA

very fine, sharp tips for SMD applications.



dpvlink 7840			
Article	Type	L [mm]	QR
P-5SA	Tweezers 5 SA	110	

Tweezers 5A SA

with very fine, sharp and beveled tips.



dpvlink 7834			
Article	Type	L [mm]	QR
P-5ASA	Tweezers 5A SA	120	

Tweezers 5B SA

with very fine, sharp tips for SMD applications. Angled by 40° for a better visibility of the working area.



dpvlink 7836			
Article	Type	L [mm]	QR
P-5BSA	Tweezers 5B SA	110	

Tweezers 5C SA

with sharp, robust tips for SMD applications.



dpvlink 7838

Article	Type	L [mm]
P-5CSA	Tweezers 5C SA	100



Tweezers 7 SA

with very fine, angled tips for an easier gripping in working areas that are difficult to reach.



dpvlink 7850

Article	Type	L [mm]
P-7SA	Tweezer type 7 SA	120



Tweezers 7A SA

with very fine, angled, robust tips for an easier gripping in working areas that are difficult to reach



dpvlink 7844

Article	Type	L [mm]
P-7ASA	Tweezers 7A SA	120



Tweezers 7B SA

with very fine, angled tips for an easier gripping in working areas that are difficult to reach. Tips inside serrated.



dpvlink 7846

Article	Type	L [mm]
P-7BSA	Tweezers 7B SA	120



Tweezers 7E SA

with very fine, flat and angled tips for an easier gripping in working areas that are difficult to reach.



dpvlink 7848

Article	Type	L [mm]
P-7ESA	Tweezers 7E SA	120



Tweezers 13S SA

with sturdy, flat, serrated tips.



dpvlink 7798

Article	Type	L [mm]
P-13SSA	Tweezers 13S SA	120



Tweezers 19 SA

for SMD applications, serrated tips and handles.



dpvlink 7804

Article	Type	L [mm]
P-19SA	Tweezers 19 SA	160



Tweezers 26 SA

with very sturdy and flat tips



dpvlink 7810

Article	Type	L [mm]
P-26SA	Tweezers 26 SA	135



Tweezers 27 SA

very sturdy, flat and thin tips.



dpvlink 7812

Article	Type	L [mm]
P-27SA	Tweezers 27 SA	135



Tweezers 35A SA

for the processing of flat components such as wafers and capacitors.



dpvlink 7820

Article	Type	L [mm]
P-35ASA	Tweezers 35A SA	120



Tweezers 65A SA

with long, thin handles and very fine tips angled by 40° for gripping conventional microchips and micro components.



dpvlink 7842

Article	Type	L [mm]
P-65ASA	Tweezers 65A SA	135



Tweezers 150 / 1.5 SA

for the insertion and extraction of micro components. Tip diameter: 1.5 mm



dpvlink 7800

Article	Type	L [mm]
P-150/1.5SA	Tweezers 150 / 1.5 SA	120



Tweezers 151 SA

for the insertion and extraction of micro components. Tip diameter: 3.0 mm



dpvlink 7802

Article	Type	L [mm]
P-151SA	Tweezers 151 SA	125



Tweezers 231 SA

with inside serrated tips for general applications.



dpvlink 7808

Article	Type	L [mm]
P-231SA	Tweezers 231 SA	120



Tweezers A SA

sturdy, precise tips for angled wires and components.



dpvlink 7856

Article	Type	L [mm]
P-ASA	Tweezers A SA	115



Tweezers AA SA

with strong gripping effect.



dpvlink 7852			
Article	Type	L [mm]	QR
P-AASA	Tweezers AA SA	130	

Tweezers AC SA

with sturdy tips and serrated handles for a safe grip.



dpvlink 7854			
Article	Type	L [mm]	QR
P-ACSA	Tweezers AC SA	110	

Placement tweezers 578 SA

for the processing and assembly of cylindrical parts of up to \varnothing 2 mm.



dpvlink 7832			
Article	Type	L [mm]	QR
P-578SA	Placement tweezers 578 SA	120	

SMD tweezers 38 SA

with recesses at the tips for the processing of wires or small parts of up to \varnothing 1 mm.



dpvlink 7822			
Article	Type	L [mm]	QR
P-38SA	SMD tweezers 38 SA	120	

SMD tweezers 102 SA

for the processing of chips and SMD components; angled tips for fatigue-free working.



dpvlink 7778			
Article	Type	L [mm]	QR
P-102SA	SMD tweezers 102 SA	120	

SMD tweezers 103 SA

for processing chips and SMD components; angled tips for fatigue-free working.



dpvlink 7780			
Article	Type	L [mm]	QR
P-103SA	SMD tweezers 103 SA	120	

SMD tweezers 104 SA

for the processing of SMD components.



dpvlink 7782			
Article	Type	L [mm]	QR
P-104SA	SMD tweezers 104 SA	120	

SMD tweezers 105 SA

with angled tips for the processing of SMD components.



dpvlink 7784			
Article	Type	L [mm]	QR
P-105SA	SMD tweezers 105 SA	120	

SMD tweezers 106 SA

for the processing of SMD components.



dpvlink 7786			
Article	Type	L [mm]	QR
P-106SA	SMD tweezers 106 SA	120	

SMD tweezers 107 SA

with recesses on the tips for the processing of SMD components of up to \varnothing 0.75 mm.



dpvlink 7788			
Article	Type	L [mm]	QR
P-107SA	SMD tweezers 107 SA	120	

SMD tweezers 108 SA

for the processing of SMD components.



dpvlink 7790			
Article	Type	L [mm]	QR
P-108SA	SMD tweezers 108 SA	120	

SMD tweezers 109 SA

for the processing of SMD components.



dpvlink 7792			
Article	Type	L [mm]	QR
P-109SA	SMD tweezers 109 SA	120	

SMD tweezers 110 SA

for the processing of SMD components.



dpvlink 7794			
Article	Type	L [mm]	QR
P-110SA	SMD tweezers 110 SA	120	

SMD tweezers 111 SA

for the processing of SMD components.



dpvlink 7796			
Article	Type	L [mm]	QR
P-111SA	SMD tweezers 111 SA	120	

ESD tweezers 5 SA

with very fine, sharp tips for SMD applications. With ESD coating.



dpvlink 17631			
Article	Type	L [mm]	QR
P-5SA.ESD	Tweezers 5 SA	110	

Piergiacomini Screwdrivers



Precision screwdriver

- swivel head
- ergonomic handle
- tip burnished
- **material:** chrome-vanadium-molybdenum steel

Slotted screwdriver PG 1



dpvlink 6010



Article	Tip	Shank	Diameter
PG1-0.D	1.2 mm	60 mm	2.5 mm
PG1-1.D	1.5 mm	60 mm	2.5 mm
PG1-2.D	1.8 mm	60 mm	2.5 mm
PG1-3.D	2.5 mm	75 mm	2.5 mm
PG1-4.D	3.0 mm	100 mm	3.0 mm
PG1-5.D	3.0 mm	150 mm	3.0 mm

PH Phillips screwdriver PG2



dpvlink 6397



Article	Tip	Shank	Diameter
PG2-0.D	PH000	60 mm	2.5 mm
PG2-1.D	PH00	60 mm	2.5 mm
PG2-1/75.D	PH00	75 mm	2.5 mm
PG2-2.D	PH0	60 mm	3.0 mm
PG2-2/75.D	PH0	75 mm	3.0 mm
PG2-2/100.D	PH0	100 mm	3.0 mm
PG2-2/150.D	PH0	150 mm	3.0 mm

Pozidriv screwdriver PG3



dpvlink 6401



Article	Tip	Shank	Diameter
PG3-0.D	PZ0	60 mm	3.0 mm

TORX® screwdriver PG4



dpvlink 6403



Article	Tip	Shank	Diameter
PG4-0X.D	TX05	50 mm	3.5 mm
PG4-0.D	TX06	50 mm	3.5 mm
PG4-1.D	TX07	50 mm	3.5 mm
PG4-2.D	TX08	60 mm	3.5 mm
PG4-3.D	TX09	60 mm	3.5 mm
PG4-4.D	TX10	60 mm	3.5 mm
PG4-5.D	TX15	60 mm	3.5 mm

TORX® screwdriver PG5



with holes

dpvlink 7727



Article	Tip	Shank	Diameter
PG5-0X.D	TR05	50 mm	3.5 mm
PG5-0.D	TR06	50 mm	3.5 mm
PG5-1.D	TR07	50 mm	3.5 mm
PG5-2.D	TR08	60 mm	3.5 mm
PG5-3.D	TR09	60 mm	3.5 mm
PG5-4.D	TR10	60 mm	3.5 mm
PG5-5.D	TR15	60 mm	3.5 mm

CK Screwdrivers

Series TRITON



TRITON ESD combines the advantages of dissipative materials with an ergonomic shape of the handle. In contrast to the especially light, small XonicXM screwdrivers, Triton ESD offers a bigger gripping volume and blades for larger screws.

Dissipative tools offer no protection against voltages, because they have no insulating properties.



- Ergonomic tri-lobe handle for comfort and effective delivery of torque
- Completely ESD compliant
- Hardened alloy steel blade for exceptional strength and durability
- Special coating eliminates the risk of reflections and flaking
- Handle injection molded directly to blade assuring increased bond
- Precision-machined tip for an exact screw fit and damage-free tightening

TRITON 4725ESD slotted



Chrome-vanadium steel
DIN EN 100 015-1, DIN 5263, DIN 5264B; DIN 5268-2; ISO 2380-1

dpvlink 1106

Article	Thickness	Shank	Diameter
4725ESD.75x3	0.5 mm	75 mm	3.0 mm
4725ESD.100x3	0.5 mm	75 mm	3.0 mm
4725ESD.100x4	0.8 mm	100 mm	4.0 mm
4725ESD.125x5	0.8 mm	125 mm	5.0 mm
4725ESD.250x5	0.8 mm	250 mm	5.0 mm

TRITON 4722ESD PH Phillips



Chrome-molybdenum steel
DIN EN 100 015-1, DIN 5261, DIN 5262; DIN 5268-2; ISO 2380-1

dpvlink 1258

Article	Tip	Shank	Diameter
4722ESD.PH0x60	PH0	60 mm	3.5 mm
4722ESD.PH1x80	PH1	80 mm	5.0 mm
4722ESD.PH1x300	PH1	300 mm	5.0 mm
4722ESD.PH2x100	PH2	100 mm	6.0 mm
4722ESD.PH2x300	PH2	300 mm	6.0 mm

TRITON 4723ESD PZD/ SDV Pozidriv / Supadriv



Chrome-molybdenum steel
DIN EN 100 015-1

dpvlink 1271

Article	Tip	Shank	Diameter
4723ESD.PZDSDV.060	PZD0	60 mm	3.5 mm
4723ESD.PZDSDV.080	PZD1	80 mm	5.0 mm
4723ESD.PZDSDV.100	PZD2	100 mm	6.0 mm

TRITON 4718ESD Torx Tamperproof



Chrome-vanadium steel, with hole = tamper-proof
DIN EN 100 015-1

dpvlink 1288

Article	Tip	Shank	Diameter
4718ESD.TX08x70	TX08	70 mm	3.0 mm
4718ESD.TX08x200	TX08	200 mm	3.0 mm
4718ESD.TX09x70	TX09	70 mm	3.0 mm
4718ESD.TX10x80	TX10	80 mm	3.0 mm
4718ESD.TX10x300	TX10	300 mm	3.0 mm
4718ESD.TX15x80	TX15	80 mm	3.5 mm
4718ESD.TX15x300	TX15	300 mm	3.5 mm
4718ESD.TX20x90	TX20	90 mm	4.0 mm

TRITON 4582ESD Bit holder



Bit holder with snap ring, without magnet, EMC compatible, 1/4" hexagon C 6.3

dpvlink 1615

Article	Shank	Diameter
4582ESD.C6.3	120 mm	11.0 mm

Triton ESD Screwdriver set



dpvlink 1251

Article	Type
4741ESD	ESD Screwdriver Set 4725 ESD.75x3, 100x3, 125x5 4723 ESD.PZDSDV 0, 1, 2
4741S-ESD	ESD Screwdriver Set 4725 ESD.75x3, -100x3, -125x5 4722 ESD.PH 0, 1, 2
4730ESD	ESD Screwdriver Set 4718 ESD.TX 08, 09, 10, 15, 20

Triton ESD screwdriver set 6-piece SL / PH / TX



For an extra long reach.

- 1 x slotted, size 5 x 250 mm
- 2 x PH, sizes 1 x 300 mm and 2 x 300 mm
- 3 x TX, sizes 8 x 200 mm, 10 x 300 mm and 15 x 300 mm

dpvlink 21578

Article	Type
4797-ESD	ESD screwdriver set 6-piece T4725ESD 5 x 250, T4722ESD PH 1 x 300, PH 2 x 300 T4718ESD T08x200, T10x300, T15x300

Series XONIC



When working on electronic components, static electricity can lead to damages or the destruction of sensitive semiconductors and other components.

Therefore, precautions are essential when working with electrostatically sensitive components.

The dissipative screwdriver tools by C.K offer an additional protection when working in electrostatically sensitive areas (ESD).

XonicXM ESD / ETUC screwdriver tools:

Manufactured and tested according to DIN 91953 as well as DIN EN 100-015/1



The handle sleeves do not provide any protection against voltage.

XONIC 4880X-ESD Slotted



dpvlink 1626

Article	Tip	Thickness	Shank	Diameter
4880X-ESD0.8x60	0.8 mm	0.2 mm	60 mm	2.5 mm
4880X-ESD1.2x60	1.2 mm	0.25 mm	60 mm	2.5 mm
4880X-ESD1.5x60	1.5 mm	0.3 mm	60 mm	2.5 mm
4880X-ESD1.8x60	1.8 mm	0.3 mm	60 mm	2.5 mm
4880X-ESD2.5x60	2.5 mm	0.4 mm	60 mm	2.5 mm
4880X-ESD2.5x75	2.5 mm	0.4 mm	75 mm	2.5 mm
4880X-ESD3.0x100	3.0 mm	0.5 mm	100 mm	3.0 mm
4880X-ESD4.0x100	4.0 mm	0.6 mm	100 mm	4.0 mm

XONIC 4882X-ESD PH / Cross-tip



dpvlink 1639

Article	Tip	Shank	Diameter
4882X-ESD000x60	PH000	60 mm	2.5 mm
4882X-ESD00x60	PH00	60 mm	2.5 mm
4882X-ESD0x60	PH0	60 mm	3.0 mm
4882X-ESD1x80	PH1	80 mm	4.5 mm

XONIC 4875X-ESD PZD / Cross-tip



dpvlink 1647

Article	Tip	Shank	Diameter
4875X-ESD0x60	PZD0	60 mm	3.0 mm
4875X-ESD1x80	PZD1	80 mm	4.5 mm

XONIC 4877X-ESD TORX®



dpvlink 1656

Article	Tip	Shank	Diameter
4877X-ESDTX04x50	TX04	50 mm	2.5 mm
4877X-ESDTX05x50	TX05	50 mm	2.5 mm
4877X-ESDTX06x50	TX06	50 mm	3.5 mm
4877X-ESDTX07x50	TX07	50 mm	3.5 mm
4877X-ESDTX08x60	TX08	60 mm	3.5 mm

XONIC 4838X-ESD Hexagon ballpoint



dpvlink 1651

Article	Size	Shank	Diameter
4838X-ESD1.5x50	1.5 mm	50 mm	2.5 mm
4838X-ESD2.0x50	2.0 mm	50 mm	2.5 mm
4838X-ESD2.5x60	2.5 mm	60 mm	3.0 mm
4838X-ESD3.0x60	3.0 mm	60 mm	3.5 mm

XONIC 4840X-ESD Socket wrench



dpvlink 1681

Article	Size	Shank	Diameter
4840X-ESD3.2x60	3.2 mm	60 mm	4.0 mm
4840X-ESD3.5x60	3.5 mm	60 mm	4.0 mm
4840X-ESD4.0x60	4.0 mm	60 mm	4.0 mm
4840X-ESD4.5x60	4.5 mm	60 mm	4.0 mm
4840X-ESD5.0x60	5.0 mm	60 mm	4.0 mm
4840X-ESD5.5x60	5.5 mm	60 mm	4.0 mm

XONIC 4845-ESD Ceramic trimmer slotted



dpvlink 1687

Article	Tip	Thickness	Shank	Diameter
4845-ESD0.9x15	0.9 mm	0.4 mm	15 mm	1.8 mm
4845-ESD1.3x15	1.3 mm	0.4 mm	15 mm	1.8 mm
4845-ESD1.8x15	1.8 mm	0.4 mm	15 mm	1.8 mm
4845-ESD2.6x15	2.6 mm	0.4 mm	15 mm	2.6 mm

XONIC 4847-ESD Ceramic trimmer PH / cross-tip



4847-ESD0x15 special with extra flat tip.

dpvlink 1697

Article	Tip	Shank	Diameter
4847-ESD0x15	PH0	15 mm	2.6 mm
4847-ESD0x15spec	PH0	15 mm	2.6 mm

XONIC ESD screwdriver set 4-piece SL/PH



Slotted screwdriver 1.8 x 60, 3 x 100, 4 x 150 mm
Crosstip screwdriver PH 0 x 60

dpvlink 21582

Article	Type
4884X-ESD	ESD screwdriver set 4-piece

XONIC ESD screwdriver set 7-piece SL/PH



dpvlink 21580

Article	Type
4883X-ESD	ESD screwdriver set 7-piece Slotted screwdriver 2.5 x 75, 3.0 x 100, 3.0 x 150, 4.0 x 100, 4.0 x 150 mm Crosstip screwdriver PH 0 x 60, 1 x 80 mm

Other screwdrivers

Socket wrench set 1/4 inch



- metric socket wrench set
- made of alloyed chrome-vanadium steel
- two-component handle
- sockets apply torque to the socket flat, not to the corners (to avoid an abrasion of the screws)

Scope of delivery:

- 1/4 inch ratchet with ejection button, 45 teeth
- inserts: 4 / 4.5 / 5 / 5.5 / 6 / 7 / 8 / 9 / 10 / 11 / 12 / 13 / 14 mm
- Bits:
 - hexagon: 3, 4, 5, 6 mm
 - safety Torx: T8, 10, 15, 20, 25, 27, 30, 40
 - Pozidriv: 1, 2, 3
 - Philips: 1, 2, 3
 - slotted: 4 / 5.5 / 7 mm
- extension 50 mm
- extension / drive handle 50 mm
- cardan joint
- adapter

dpvlink 21584

Article	Type
4655	Socket wrench set 1/4", 39-piece

Screwdriver set 7-piece MULTI-BLADE



Ergonomically shaped handle with hollow rotating cap for an simple manipulation and precise control. Interchangeable reversible blades of high-quality chrome-vanadium / molybdenum steel.

Scope of delivery:

- screwdriver handle
- reversible blades
 - blades 1.5 / 2.0 / 3.0 / 4.0
 - PH 000 / PH 00 / PH 0 / PH 1
 - TX 05 / TX 06 / TX 07 / TX 08

dpvlink 21593

Article	Type
4896	Screwdriver set 7-piece

ESD Wiha Screwdrivers



Screwdrivers with blades of high-quality chrome-vanadium-molybdenum steel, completely hardened, matt chrome-plated.

In compliance with the ESD standard DIN EN 61340-5-1



The Wiha ChromTop blade tip guarantees highest dimensional accuracy.

Soft finish® is a patented handle design by Wiha. The impact-resistant polypropylene (PP), coated with skin-friendly thermoplastic elastomer (TPE), provides a solid stability in the core of the handle. The ideal combination of materials offers a better grip and a higher slip resistance. Due to the unique, ergonomically perfect shape, the handles fit extremely well in the hand.

ESD SoftFinish® RapidFix bit holder



A safe, almost backlash holding for all bits and bit drills with shape C 6.3, E 6.3 or double bits. A true one-hand operation for fast bit exchanges, extremely high retention force of the bits (up to 20 kg).

dpvlink 9701

Article	Type
387ESD.7148	ESD SoftFinish® RapidFix bit holder
281-01ESD	ESD SoftFinish® bit holder Stubby



Slotted screwdriver 302 ESD Softfinish®



dpvlink 6407

Article	Tip	Thickness	Shank	Diameter
302ESD.75x2.5	2.5 mm	0.4 mm	75 mm	2.5 mm
302ESD.100x3.0	3.0 mm	0.5 mm	100 mm	3.0 mm
302ESD.100x4.0	4.0 mm	0.8 mm	100 mm	4.0 mm
302ESD.125x5.5	5.5 mm	1.0 mm	125 mm	5.5 mm
302ESD.150x6.5	6.5 mm	1.2 mm	150 mm	6.0 mm



Phillips screwdriver 311 ESD Softfinish®



dpvlink 6413

Article	Tip	Shank	Diameter
311ESD.PH0x60	PH0	60 mm	3.0 mm
311ESD.PH1x80	PH1	80 mm	4.5 mm
311ESD.PH2x100	PH2	100 mm	6.0 mm



Pozidriv screwdriver 313 ESD SoftFinish®



dpvlink 6417

Article	Tip	Shank	Diameter
313ESD.PZ0x60	PZ0	60 mm	3.0 mm
313ESD.PZ1x80	PZ1	80 mm	4.5 mm



TORX® screwdriver 362 ESD SoftFinish®



dpvlink 6420

Article	Tip	Shank	Diameter
362ESD.TX03x60	TX03	60 mm	2.5 mm
362ESD.TX04x60	TX04	60 mm	2.5 mm
362ESD.TX05x60	TX05	60 mm	3.5 mm
362ESD.TX06x60	TX06	60 mm	3.5 mm
362ESD.TX07x60	TX07	60 mm	2.5 mm
362ESD.TX08x60	TX08	60 mm	3.5 mm
362ESD.TX09x60	TX09	60 mm	4.0 mm
362ESD.TX10x80	TX10	80 mm	4.0 mm
362ESD.TX15x80	TX15	80 mm	4.0 mm
362ESD.TX20x100	TX20	100 mm	4.0 mm



Wiha Softfinish® ESD screwdriver sets



dpvlink 6429

Article	Type
302ESD.HK5.01	Slotted/Phillips ESD screwdriver set 5-piece 302 302ESD.100x3.0, 100x4.0, 311ESD.PH0x60, PH1x80, PH2x100
362ESD.Set	TORX® ESD screwdriver set 5-piece 362ESD.TX06x60, TX08x60, TX09x60, TX10x80, TX15x80



Slotted screwdriver 270P ESD PicoFinish®



dpvlink 22956

Article	Tip	Thickness	Shank	Diameter
270P.40x1.5	1.5 mm	0.25 mm	40 mm	2.0 mm
270P.40x2.0	2.0 mm	0.4 mm	40 mm	2.0 mm
270P.50x2.5	2.5 mm	0.4 mm	50 mm	2.5 mm
270P.50x3.0	3.0 mm	0.5 mm	50 mm	3.0 mm
270P.60x3.5	3.5 mm	0.6 mm	60 mm	3.5 mm
270P.60x4.0	4.0 mm	0.8 mm	60 mm	4.0 mm



Phillips screwdriver 271P ESD PicoFinish®



dpvlink 22963

Article	Tip	Shank	Diameter
271P.PH00x40	PH00	40 mm	2.0 mm
271P.PH00x40	PH00	40 mm	2.0 mm
271P.PH0x50	PH0	50 mm	3.0 mm
271P.PH1x60	PH1	60 mm	4.0 mm



Screwdrivers

Hexagon screwdriver 273P ESD PicoFinish®



dpvlink 22990



Article	Tip	Shank
273P.40x0.7	0.7 mm	40 mm
273P.40x0.9	0.9 mm	40 mm
273P.40x1.3	1.3 mm	40 mm
273P.50x1.5	1.5 mm	50 mm
273P.50x2.0	2.0 mm	50 mm
273P.60x2.5	2.5 mm	60 mm
273P.60x3.0	3.0 mm	60 mm

Hexagon wrench 275P ESD PicoFinish®



dpvlink 23000



Article	Size	Shank
275P.60x2.5	2.5 mm	60 mm
275P.60x3.0	3.0 mm	60 mm
275P.60x3.5	3.5 mm	60 mm
275P.60x4.0	4.0 mm	60 mm
275P.60x5.0	5.0 mm	60 mm
275P.60x5.5	5.5 mm	60 mm

TORX® screwdriver 277P ESD PicoFinish®



dpvlink 23010



Article	Tip	Shank	Diameter
277P.TX01x40	TX01	40 mm	2.5 mm
277P.TX02x40	TX02	40 mm	2.5 mm
277P.TX03x40	TX03	40 mm	2.5 mm
277P.TX04x40	TX04	40 mm	2.5 mm
277P.TX05x40	TX05	40 mm	2.5 mm
277P.TX06x40	TX06	40 mm	2.5 mm
277P.TX07x40	TX07	40 mm	2.5 mm
277P.TX08x40	TX08	40 mm	2.5 mm
277P.TX09x50	TX09	50 mm	3.0 mm
277P.TX10x50	TX10	50 mm	3.0 mm
277P.TX15x60	TX15	60 mm	3.5 mm
277P.TX20x60	TX20	60 mm	4.0 mm

Lifter ESD PicoFinish®

For removing tight components from printed circuit boards



dpvlink 22968



Article	Tip	Shank
278P.1001	3.5 mm	50 mm

ESD screwdriver sets



Screwdrivers with blades of high-quality chrome-vanadium-molybdenum steel, completely hardened, matt chrome-plated

dpvlink 6987



Article	Type
270PESD.Set	Slotted/Phillips screwdriver set, 6-piece, ESD Slotted: 1.5, 2.0, 2.5, 3.0 Phillips: PH 00, PH 0
277PESD.Set	TORX® ESD screwdriver set 6-piece T5, T6, T7, T8, T10, T15

Wiha ESD System 4

- Flexible, versatile precision reversible blade system
- Handles electrostatically dissipative, surface resistance $10^6 - 10^9$ ohm,
- Fulfills the ESD standard IEC 61340-5-1
- Ergonomic SoftFinish® multi-component handle ensures a comfortable screwing and an optimal handling
- Color-coded blades of high-quality, hard but elastic chrome-vanadium-molybdenum steel, completely hardened, matt chrome-plated
- Wiha ChromTop® tips guarantee highest dimensional accuracy

SYSTEM 4 SoftFinish® telescopic ESD



Handle: Ergonomic multi-component handle with roll-off protection. With 4 mm hexagon socket for all SYSTEM 4 blades. Allows a variable length adjustment of the reversible blade of 18-90 mm. The ClickStop ball clamp guarantees a safe grip and fast blade exchange. Surface resistance 10^6-10^9 ohm.

Standards: IEC61340-5-1

Application: For all works on electrostatically sensitive components.

dpvlink 12729



Article	Type	
2691ESD.4	SYSTEM 4 SoftFinish® telescopic ESD 4.0	105

SYSTEM 4 Slotted reversible blade



High-quality chrome-vanadium-molybdenum steel, completely hardened, matt chrome-plated. Wiha ChromTop® blade tips.

dpvlink 12731



Article	L [mm]	Tip	Thickness	Ø
269.15/30	120 mm	0.25/ 0.5 mm	1.5/ 3.0 mm	4.0 mm
269.20/35	120 mm	0.4/ 0.6 mm	2.0/ 3.5 mm	4.0 mm
269.25/40	120 mm	0.4/ 0.8 mm	2.5/ 4.0 mm	4.0 mm

SYSTEM 4 Combined slotted-Phillips reversible blade



High-quality chrome-vanadium-molybdenum steel, completely hardened, matt chrome-plated. Wiha ChromTop® blade tips.

dpvlink 12735

Article	L [mm]	Tip	Thickness	Ø
269.20/PH00	120 mm	0.4 / PH00	2.0 mm	4.0 mm
269.30/PH0	120 mm	0.5 / PH0	3.0 mm	4.0 mm
269.40/PH1	120 mm	0.8 / PH1	4.0 mm	4.0 mm

SYSTEM 4 Phillips reversible blade



High-quality chrome-vanadium-molybdenum steel, completely hardened, matt chrome-plated. Wiha ChromTop® blade tips.

dpvlink 12739

Article	L [mm]	Tip	Ø
269.PH000/00	120 mm	PH000/PH00	4.0 mm
269.PH0/1	120 mm	PH0/PH1	4.0 mm

SYSTEM 4 Pozidriv reversible blade



High-quality chrome-vanadium-molybdenum steel, completely hardened, matt chrome-plated. Wiha ChromTop® blade tips.

dpvlink 12742

Article	L [mm]	Tip	Ø
269.PZ0/1	120 mm	PZ0/PZ1	4.0 mm

SYSTEM 4 TORX® reversible blade



High-quality chrome-vanadium-molybdenum steel, completely hardened, matt chrome-plated. Wiha ChromTop® blade tips.

dpvlink 12744

Article	L [mm]	Tip	Ø
269.T01/02	120 mm	T1/T2	4.0 mm
269.T03/04	120 mm	T3/T4	4.0 mm
269.T05/06	120 mm	T5/T6	4.0 mm
269.T06/08	120 mm	T6/T8	4.0 mm
269.T07/09	120 mm	T7/T9	4.0 mm
269.T10/15	120 mm	T10/T15	4.0 mm
269.T15/20	120 mm	T15/T20	4.0 mm

SYSTEM 4 Combined hexagon ballpoint - hexagon reversible blade



Blade: high-quality chrome-vanadium-molybdenum steel, completely hardened, matt chrome-plated. Wiha ChromTop® blade tips.

Extra: for screwing at an angle of up to 25°

dpvlink 12752

Article	L [mm]	Tip	Ø
269.SK13	120 mm	1.3/ 1.3 mm	4.0 mm
269.SK15	120 mm	1.5/ 1.5 mm	4.0 mm
269.SK20	120 mm	2.0/ 2.0 mm	4.0 mm
269.SK25	120 mm	2.5/ 2.5 mm	4.0 mm
269.SK30	120 mm	3.0/ 3.0 mm	4.0 mm
269.SK40	120 mm	4.0/ 4.0 mm	4.0 mm

SYSTEM 4 Bit holder



Socket for C4 (4 mm) bits

Chrome-vanadium steel, completely hardened, galvanically refined

dpvlink 12759

Article	L [mm]	Tip	Thickness	D Head
U759.00	135 mm	4.0 mm	4.0 mm	9.0 mm

SYSTEM 4 Set in roll-up bag



11-piece set in ESD safe roll-up bag, SYSTEM 4 SoftFinish® telescopic ESD handle, matt chrome-plated, high-quality chrome-vanadium-molybdenum steel, completely hardened

Color-coded Wiha ChromTop® blades:

Slotted / Phillips / TORX® / hexagon ballpoint

dpvlink 6985

Article	Type
2691ESD.Set	SYSTEM 4 Set in roll-up bag SoftFinish® handle ESD, slotted: 0.25 x 1.5 - 0.5 x 3.0, 0.4 x 2.0 - 0.6 x 3.5, 0.4 x 2.5 - 8 x 4.0 Phillips: PH 000 - 00 PH, PH 0 - PH 1, TORX®: T6 - T8, T7 - T9, hexagon ballpoint: 1.5, 2.0, 2.5

SYSTEM 4 ESD set 16-piece



SYSTEM 4 SoftFinish® telescopic ESD handle. Mixed equipment. Variably adjustable bit holder blade length; 14 bits + metal storage box

- Robust and space-saving metal box
- bit set suitable for the smallest screws with electronic components
- flexible working due to variably adjustable blade length and quick changing of the bit insert
- DIN 3126, ISO 1173, shape C 4. IEC 61340-5-1

dpvlink 13265

Article	Type
7000EB16ESD.Set	SYSTEM 4 ESD set 16-piece SYSTEM 4 SoftFinish® telescopic ESD handle. SYSTEM 4 bit holder; slotted: 1 x 2.0, 1 x 3.0; cross-tip: 1xPH00, 1xPH00, 1xPH0, 1xPH1; Torx: 1xT3, 1xT4, 1xT5, 1xT6, 1xT8; hexagon: 1 x 0.9, 1 x 1.3, 1 x 1.5

SYSTEM 4 ESD set 26-piece



SYSTEM 4 SoftFinish® telescopic ESD handle. Mixed equipment. Variably adjustable bit holder blade length; 24 bits + metal storage box

- Robust and space-saving metal box
- bit set suitable for the smallest screws with electronic components
- flexible working due to variably adjustable blade length and quick changing of the bit insert
- DIN 3126, ISO 1173, shape C 4. IEC 61340-5-1

dpvlink 13267

Article	Type
7000EB26ESD.Set	SYSTEM 4 ESD set 26-piece SYSTEM 4 SoftFinish® telescopic ESD handle. SYSTEM 4 bit holder; slotted: 1 x 1.5, 1 x 2.0, 1 x 3.0 1 x 4.0; cross-tip: 1xPH00 1xPH00 1xPH0 1xPH1; Torx: 1xT3 1xT4 1xT5 1xT6 1xT7 1xT8 1xT9 1xT10; hexagon: 1 x 0.7, 1 x 0.9, 1 x 1.3, 1 x 1.5, 1 x 2.0, 1 x 2.5, 1 x 3.0, 1 x 4.0

Wiha ESD System 6

The **Wiha SYSTEM 6** combination blade systems are high-quality products in industrial quality meeting the highest requirements due to the first-class materials and processing. The 150 mm long reversible blades are made of chrome-vanadium-molybdenum steel, completely hardened and matt chrome-plated. The different handles are particularly ergonomic and guarantee an optimal power transmission.

SYSTEM 6 ESD SoftFinish® telescopic



Ergonomic multi-component handle with roll-off protection. With 6 mm hexagon socket. Allows a variable length adjustment of the reversible blade from 42-114 mm. ClickStop ball clamp ensures safe grip and quick blade exchange. Surface resistance 10⁶-10⁹ ohm.

dpvlink 12677

Article	Type	
284ESD	SYSTEM 6 ESD SoftFinish® telescopic	115

SYSTEM 6 Slotted reversible blade



High-quality chrome-vanadium-molybdenum steel, completely hardened, matt chrome-plated. Wiha ChromTop® blade tips.

dpvlink 12680

Article	L [mm]	Tip	Thickness	Diameter
284.35/45	150 mm	0.6/ 0.8 mm	3.5/ 4.5 mm	6.0 mm
284.40/60	150 mm	0.8/ 1.0 mm	4.0/ 6.0 mm	6.0 mm
284.55/65	150 mm	1.0/ 1.2 mm	5.5/ 6.5 mm	6.0 mm

SYSTEM 6 Combined slotted-Phillips reversible blade



High-quality chrome-vanadium-molybdenum steel, completely hardened, matt chrome-plated. Wiha ChromTop® blade tips.

dpvlink 12690

Article	L [mm]	Tip	Thickness	Diameter
284.40/PH1	150 mm	0.8 / PH1	4.0 mm	6.0 mm
284.60/PH2	150 mm	1.0 / PH2	6.0 mm	6.0 mm

SYSTEM 6 Phillips reversible blade



High-quality chrome-vanadium-molybdenum steel, completely hardened, matt chrome-plated. Wiha ChromTop® blade tips.

dpvlink 12691

Article	L [mm]	Tip	Diameter
284.PH1/2	150 mm	PH1/PH2	6.0 mm
284.PH2/3	150 mm	PH2/PH3	6.0 mm

SYSTEM 6 Pozidriv reversible blade



High-quality chrome-vanadium-molybdenum steel, completely hardened, matt chrome-plated. Wiha ChromTop® blade tips.

dpvlink 12692

Article	L [mm]	Tip	Diameter
284.PZ1/2	150 mm	PZ1/PZ2	6.0 mm
284.PZ2/3	150 mm	PZ2/PZ3	6.0 mm

SYSTEM 6 Combined hexagon ballpoint - hexagon reversible blade



High-quality chrome-vanadium-molybdenum steel, completely hardened, matt chrome-plated. Wiha ChromTop® blade tips.

dpvlink 12693

Article	L [mm]	Tip	Diameter
284.SK25	150 mm	2.5/ 2.5 mm	6.0 mm
284.SK30	150 mm	3.0/ 3.0 mm	6.0 mm
284.SK40	150 mm	4.0/ 4.0 mm	6.0 mm
284.SK50	150 mm	5.0/ 5.0 mm	6.0 mm
284.SK60	150 mm	6.0/ 6.0 mm	6.0 mm

SYSTEM 6 Torx® reversible blade



High-quality chrome-vanadium-molybdenum steel, completely hardened, matt chrome-plated. Wiha ChromTop® blade tips.

dpvlink 12704

Article	L [mm]	Tip	Diameter
284.T06/08	150 mm	T6/T8	6.0 mm
284.T07/09	150 mm	T7/T9	6.0 mm
284.T10/15	150 mm	T10/T15	6.0 mm
284.T20/25	150 mm	T20/T25	6.0 mm
284.T30/40	150 mm	T30/T40	6.0 mm

SYSTEM 6 Torx® Tamper-resistant reversible blade



For TORX® screws with locking pin. High-quality chrome-vanadium-molybdenum steel, completely hardened, matt chrome-plated. Wiha ChromTop® blade tips. With hole in the blade tip.

dpvlink 12710

Article	L [mm]	Tip	Diameter
284.T06H/08H	150 mm	T6H/T8H	6.0 mm
284.T07H/09H	150 mm	T7H/T9H	6.0 mm
284.T10H/15H	150 mm	T10H/T15H	6.0 mm
284.T20H/25H	150 mm	T20H/T25H	6.0 mm
284.T30H/40H	150 mm	T30H/T40H	6.0 mm

SYSTEM 6 Adapter blade



For wrench socket inserts with 1/4" inner square. Chrome-vanadium steel, completely hardened, matt chrome-plated. 1/4" square socket with spring-loaded ball for a perfect fit.

dpvlink 12725

Article	L [mm]	Socket	Diameter
7803	150 mm	1/4"	6.0 mm

SYSTEM 6 Bit holder



SYSTEM 6 bit holder. Socket for C 6.3 and E 6.3 (1/4") bits. Chrome-vanadium steel, completely hardened, matt chrome-plated. Bit socket made of stainless steel, with integrated permanent magnet.

dpvlink 12723

Article	L [mm]	Tip	Thickness
7802	150 mm	6.0 mm	6.0 mm

SYSTEM 6 Torq-Set® reversible blade



For Torq-set® safety screws. High-quality chrome-vanadium-molybdenum steel, completely hardened, matt chrome-plated. Wiha ChromTop® blade tips.

dpvlink 12720

Article	L [mm]	Tip	Diameter
284.TS2/4	150 mm	TS2/TS4	6.0 mm



SYSTEM 6 Reversible blade set



6-piece set, SoftFinish® telescopic ESD handle, matt chrome-plated high-quality chrome-vanadium-molybdenum steel, completely hardened

Blades:
Slotted / Phillips / hexagon ballpoint

dpvlink 6983

Article	Type
284ESD.Set	SYSTEM 6 Reversible blade set SoftFinish® ESD handle, slotted: 0.6x3.5 - 0.8x4.5, 0.8x4.0 - 1.0x6.0, 1.0x5.5 - 1.2x6.5 Phillips: PH 1, PH 2; hexagon ballpoint: 5



- further reversible blades available on request -

Wiha Screwdrivers VDE



Screwdrivers with blades made of high-quality chrome-vanadium-molybdenum steel, completely hardened, burnished. The protective insulation is molded directly onto the blade and inextricably linked to the handle.

SoftFinish® electric VDE screwdrivers by Wiha are marked with the GS symbol for tested safety. They provide safety when working with a voltage of up to 1000 V AC and 1500 V DC. In order to ensure this, each screwdriver of the series SoftFinish® electric series is tested individually in a water bath at 10,000 V, in accordance to EN/IEC 60900:2004. The ergonomic handle geometry with the skin-friendly soft zone offers ultimate comfort, even for extremely high torques.

Slotted screwdriver 320N VDE SoftFinish® electric



dpvlink 9187

Article	Tip	Thickness	Shank
320N.60x2.0	2.0 mm	0.4 mm	60 mm
320N.75x2.5	2.5 mm	0.4 mm	75 mm
320N.100x3.0	3.0 mm	0.5 mm	100 mm
320N.100x3.5	3.5 mm	0.6 mm	100 mm
320N.100x4.0	4.0 mm	0.8 mm	100 mm
320N.125x4.5	4.5 mm	1.0 mm	125 mm
320N.175x4.5	4.5 mm	1.0 mm	175 mm
320N.125x5.5	5.5 mm	1.0 mm	125 mm
320N.175x5.5	5.5 mm	1.0 mm	175 mm
320N.150x6.0	6.0 mm	1.2 mm	150 mm
320N.150x6.5	6.5 mm	1.2 mm	150 mm
320N.175x8.0	8.0 mm	1.2 mm	175 mm



Phillips screwdriver 321N VDE SoftFinish® electric



dpvlink 9201

Article	Tip	Shank
321N.PH0x60	PH0	60 mm
321N.PH1x80	PH1	80 mm
321N.PH2x100	PH2	100 mm
321N.PH3x150	PH3	150 mm
321N.PH4x200	PH4	200 mm



Pozidriv screwdrivers 324N VDE SoftFinish® electric



dpvlink 9227

Article	Tip	Shank
324.PZ0x60	PZ0	60 mm
324.PZ1x80	PZ1	80 mm
324.PZ2x100	PZ2	100 mm
324.PZ3x150	PZ3	150 mm



Hexagon socket 322N VDE Softfinish® electric



dpvlink 9207

Article	Size	Shank
322.125x4.0	4.0 mm	125 mm
322.125x5.0	5.0 mm	125 mm
322.125x5.5	5.5 mm	125 mm
322.125x6.0	6.0 mm	125 mm
322.125x7.0	7.0 mm	125 mm
322.125x8.0	8.0 mm	125 mm
322.125x9.0	9.0 mm	125 mm
322.125x10.0	10.0 mm	125 mm
322.125x11.0	11.0 mm	125 mm
322.125x12.0	12.0 mm	125 mm
322.125x13.0	13.0 mm	125 mm
322.125x14.0	14.0 mm	125 mm

Hexagon pin wrench 323N VDE SoftFinish® electric



dpvlink 9220

Article	Size	Shank
323N.75x2.5	2.5 mm	75 mm
323N.75x3.0	3.0 mm	75 mm
323N.75x4.0	4.0 mm	75 mm
323N.75x5.0	5.0 mm	75 mm
323N.100x6.0	6.0 mm	100 mm
323N.100x8.0	8.0 mm	100 mm

TORX® screwdriver 325 VDE SoftFinish® electric



dpvlink 9232

Article	Tip	Shank
325.TX05x60	TX05	60 mm
325.TX06x60	TX06	60 mm
325.TX07x60	TX07	60 mm
325.TX08x60	TX08	60 mm
325.TX09x60	TX09	60 mm

TORX® screwdriver VDE SoftFinish® electric SlimFix



dpvlink 16906

Article	Tip	Shank
3251.T10	TX10/SlimFix	100 mm
3251.T15	TX15/SlimFix	100 mm
3251.T20	TX20/SlimFix	100 mm
3251.T25	TX25/SlimFix	100 mm
3251.T27	TX27/SlimFix	125 mm
3251.T30	TX30/SlimFix	125 mm
3251.T40	TX40/SlimFix	125 mm

Wiha SoftFinish® electric VDE screwdriver sets



dpvlink 9287

Article	Type
320N.ZK6.SO	Slotted/Pozidriv screwdriver set 6-piece 320N 320N.75x2.5, 100x3.5, 125x4.5, 125x5.5 324.PZ1x80, 2x100
320N.K7	Slotted/Phillips screwdriver set 7-piece 320N.75x2.5, 100 x 4.0, 125 x 5.5, 150 x 6.5 4S300D.PH1x80, 2 x 100 255-3
320N.K6	Slotted/Phillips screwdriver set, 6-piece 320N.100x3.0, 100x4.0, 125x5.5, 150x6.5 312N.PH1x80, 2x100

Wiha SoftFinish® electric VDE screwdriver sets



dpvlink 9291

Article	Type
322.K5	Hexagon socket wrench set, 5-piece 322.125x5.5, 125x7.0, 125x8.0, 125x10.0, 125x13.0

Wiha SoftFinish® electric slimFix VDE screwdriver sets



dpvlink 16551

Article	Type
3251N.K6.01	TORX® screwdriver set, 6-piece 325.TX08x60, TX09x60; 3251.T10, T15, T20, T25

Wiha Screwdrivers



Screwdrivers with blades made of high-quality chrome-vanadium-molybdenum steel, completely hardened, matt chrome-plated. Wiha ChromTop® blade tips guarantee highest accuracy.

SoftFinish® is a patented handle concept by Wiha. The impact-resistant polypropylene (PP) coated with skin-friendly thermoplastic elastomer (TPE) provides a solid base in the core of the handle. The ideal material combination for a better gripping and a higher slip resistance. Due to the unique, ergonomically perfect shape, the handles lie extremely well in the hand.

PicoFinish screwdrivers by Wiha are characterized by the best materials and an ergonomic handle concept. The comfortable precision screwdriver with multi-component handle, rapid-turning zone and smooth-running rotating cap is ideal for all fine, filigree applications in the electro- and fine mechanics. The color-coded imprint of the screw symbol facilitates the identification.

Slotted screwdriver 302 SoftFinish®



dpvlink 9060

Article	Tip	Thickness	Shank	Diameter
302.65x2.0	2.0 mm	0.4 mm	65 mm	2.0 mm
302.75x2.5	2.5 mm	0.4 mm	75 mm	2.5 mm
302.100x3.0	3.0 mm	0.5 mm	100 mm	3.0 mm
302.100x3.5	3.5 mm	0.6 mm	100 mm	3.5 mm
302.100x4.0	4.0 mm	0.8 mm	100 mm	4.0 mm
302.125x4.5	4.5 mm	0.8 mm	125 mm	4.5 mm
302.125x5.5	5.5 mm	1.0 mm	125 mm	5.5 mm
302.150x6.0	6.0 mm	1.2 mm	150 mm	6.0 mm
302.150x6.5	6.5 mm	1.2 mm	150 mm	1.2 mm
302.150x8.0	8.0 mm	1.2 mm	150 mm	1.2 mm
302.200x10.0	10.0 mm	1.6 mm	200 mm	1.6 mm

Phillips screwdriver 311 SoftFinish®



dpvlink 9072

Article	Tip	Shank	Diameter
311.PH0x60	PH0	60 mm	3.0 mm
311.PH1x80	PH1	80 mm	4.5 mm
311.PH1x100	PH1	100 mm	4.5 mm
311.PH2x100	PH2	100 mm	6.0 mm
311.PH2x150	PH2	150 mm	6.0 mm
311.PH3x150	PH3	150 mm	8.0 mm

Pozidriv screwdriver 313 SoftFinish®



dpvlink 9080

Article	Tip	Shank	Diameter
313.PZ0x60	PZ0	60 mm	3.0 mm
313.PZ1x80	PZ1	80 mm	4.5 mm
313.PZ2x100	PZ2	100 mm	6.0 mm
313.PZ3x150	PZ3	150 mm	8.0 mm

Hexagon ballpoint screwdriver 367 SoftFinish®



The ballpoint facilitates the screwing at an angle of up to 25°.

dpvlink 9104

Article	Size	Shank
367.75x1.5	1.5 mm	75 mm
367.100x2.0	2.0 mm	100 mm
367.100x2.5	2.5 mm	100 mm
367.100x3.0	3.0 mm	100 mm
367.100x4.0	4.0 mm	100 mm
367.100x5.0	5.0 mm	100 mm
367.125x6.0	6.0 mm	125 mm
367.150x8.0	8.0 mm	150 mm

Hexagon ballpoint screwdriver 367R "MagicRing" SoftFinish®



The ballpoint allows the screwing at an angle up to 25°. The "MagicRing" spring steel ring holds hexagon screws tight.

dpvlink 9113

Article	Size	Shank
367R.100x3.0	3.0 mm	100 mm
367R.100x4.0	4.0 mm	100 mm
367R.100x5.0	5.0 mm	100 mm
367R.125x6.0	6.0 mm	125 mm
367R.150x8.0	8.0 mm	150 mm

Hexagon socket wrench 341 SoftFinish®



dpvlink 9244

Article	Size	Shank
341.125x4.0	4.0 mm	125 mm
341.125x5.0	5.0 mm	125 mm
341.125x5.5	5.5 mm	125 mm
341.125x6.0	6.0 mm	125 mm
341.125x7.0	7.0 mm	125 mm
341.125x8.0	8.0 mm	125 mm
341.125x9.0	9.0 mm	125 mm
341.125x10.0	10.0 mm	125 mm
341.125x11.0	11.0 mm	125 mm
341.125x13.0	13.0 mm	125 mm
341.125x14.0	14.0 mm	125 mm

TORX® screwdriver 362 SoftFinish®



dpvlink 9085

Article	Tip	Shank	Diameter
362.TX03x60	TX03	60 mm	2.5 mm
362.TX04x60	TX04	60 mm	2.5 mm
362.TX05x60	TX05	60 mm	2.5 mm
362.TX06x60	TX06	60 mm	3.5 mm
362.TX07x60	TX07	60 mm	3.5 mm
362.TX08x60	TX08	60 mm	3.5 mm
362.TX09x60	TX09	60 mm	4.0 mm
362.TX10x80	TX10	80 mm	4.0 mm
362.TX15x80	TX15	80 mm	4.0 mm
362.TX20x100	TX20	100 mm	4.0 mm

Screwdrivers

TORX® screwdriver 362R "MagicSpring" SoftFinish®



The "MagicSpring" retaining spring holds TORX® screws tight.

dpvlink 9096



Article	Tip	Shank	Diameter
362R.TX06x60	TX06	60 mm	3.5 mm
362R.TX07x60	TX07	60 mm	3.5 mm
362R.TX08x60	TX08	60 mm	3.5 mm
362R.TX09x60	TX09	60 mm	4.0 mm
362R.TX10x80	TX10	80 mm	4.0 mm
362R.TX15x80	TX15	80 mm	4.0 mm
362R.TX20x100	TX20	100 mm	4.0 mm

Wiha SoftFinish® screwdriver sets



dpvlink 9262



Article	Type
302.HK6.SO	Slotted/Phillips screwdriver set, 6-piece 302. 100 x 3.5, 125 x 4.5, 150 x 5.5, 150 x 6.5 311.PH1x80, PH2x100
302.ZK6.SO	Slotted/Pozidriv screwdriver set, 6-piece 302. 100 x 3.5, 125 x 4.5, 150 x 5.5, 150 x 6.5 313.PZ1x80, PZ2x100
302.HK6.01	Slotted/Phillips/Pozidriv screwdriver set, 6-piece 302.100x4.0, 125x5.5, 150x6.5 311.PH1x80, PH2x100, PH3x150 313.PZ2x100
311.K6	Phillips/Pozidriv screwdriver set, 6-piece 311.PH1x80, PH2x100, PH3x150 313.PZ1x80, PZ2x100, PZ3x150

Wiha SoftFinish® screwdriver sets



dpvlink 9267



Article	Type
362.K6.SO	TORX® screwdriver set, 6-piece 362.TX10x80, TX15x80, TX20x100, TX25x100, TX30x115, TX40x130
362R.K6.SO	TORX® screwdriver set "MagicSpring", 6-piece 362R.TX10x80, TX15x80, TX20x80, TX25x100, TX30x115, TX40x130
362.K7	TORX® screwdriver set, 7-piece 362.TX08x60, TX09x60, TX10x80, TX15x80, TX20x100, TX25x100, TX30x115

Wiha SoftFinish® socket wrench sets



dpvlink 9271



Article	Type
341.K5	Hexagon socket wrench set, 5-piece 341.125x5.5, 125x7.0, 125x8.0, 125x10.0, 125x13.0

Slotted screwdriver 260P PicoFinish



dpvlink 9119



Article	Tip	Thickness	Shank	Diameter
260P.40x0.8	0.8 mm	0.16 mm	40 mm	2.0 mm
260P.40x1.0	1.0 mm	0.18 mm	40 mm	2.0 mm
260P.40x1.2	1.2 mm	0.2 mm	40 mm	2.0 mm
260P.40x1.5	1.5 mm	0.25 mm	40 mm	2.0 mm
260P.40x1.8	1.8 mm	0.3 mm	40 mm	2.0 mm
260P.40x2.0	2.0 mm	0.4 mm	40 mm	2.0 mm
260P.50x2.5	2.5 mm	0.4 mm	50 mm	2.5 mm
260P.50x3.0	3.0 mm	0.5 mm	50 mm	3.0 mm
260P.60x3.5	3.5 mm	0.6 mm	60 mm	3.5 mm
260P.60x4.0	4.0 mm	0.8 mm	60 mm	4.0 mm

Phillips screwdriver 261P PicoFinish



dpvlink 9130



Article	Tip	Shank	Diameter
261P.PH00x40	PH000	40 mm	2.0 mm
261P.PH00x40	PH00	40 mm	2.0 mm
261P.PH00x50	PH0	50 mm	3.0 mm
261P.PH1x60	PH1	60 mm	4.0 mm

Pozidriv screwdriver 262P PicoFinish



dpvlink 9135



Article	Tip	Shank	Diameter
262P.PZ0x50	PZ0	50 mm	3.0 mm
262P.PZ1x60	PZ1	60 mm	4.0 mm

Hexagon screwdriver 263P PicoFinish



dpvlink 9138



Article	Size	Shank
263P.40x0.7	0.7 mm	40 mm
263P.40x0.9	0.9 mm	40 mm
263P.40x1.3	1.3 mm	40 mm
263P.50x1.5	1.5 mm	50 mm
263P.50x2.0	2.0 mm	50 mm
263P.60x2.5	2.5 mm	60 mm
263P.60x3.0	3.0 mm	60 mm

Hexagon ballpoint screwdriver 264P PicoFinish



The ballpoint facilitates the screwing at an angle of up to 25°.

dpvlink 9146



Article	Size	Shank
264P.40x1.3	1.3 mm	40 mm
264P.50x1.5	1.5 mm	50 mm
264P.50x2.0	2.0 mm	50 mm
264P.60x2.5	2.5 mm	60 mm
264P.60x3.0	3.0 mm	60 mm

Hexagon socket wrench 265P PicoFinish



dpvlink 9152



Article	Size	Shank
265P.60x1.5	1.5 mm	60 mm
265P.60x1.8	1.8 mm	60 mm
265P.60x2.0	2.0 mm	60 mm
265P.60x2.5	2.5 mm	60 mm
265P.60x3.0	3.0 mm	60 mm
265P.60x3.2	3.2 mm	60 mm
265P.60x3.5	3.5 mm	60 mm
265P.60x4.0	4.0 mm	60 mm
265P.60x4.5	4.5 mm	60 mm
265P.60x5.0	5.0 mm	60 mm
265P.60x5.5	5.5 mm	60 mm
265P.60x6.0	6.0 mm	60 mm
265P.60x7.0	7.0 mm	60 mm

TORX® screwdriver 267P PicoFinish



dpvlink 9166



Article	Tip	Shank	Diameter
267P.TX01x40	TX01	40 mm	2.5 mm
267P.TX02x40	TX02	40 mm	2.5 mm
267P.TX03x40	TX03	40 mm	2.5 mm
267P.TX04x40	TX04	40 mm	2.5 mm
267P.TX05x40	TX05	40 mm	2.5 mm
267P.TX06x40	TX06	40 mm	2.5 mm
267P.TX07x40	TX07	40 mm	2.5 mm
267P.TX08x40	TX08	40 mm	2.5 mm
267P.TX09x50	TX09	50 mm	3.0 mm
267P.TX10x50	TX10	50 mm	3.0 mm
267P.TX15x60	TX15	60 mm	3.5 mm
267P.TX20x60	TX20	60 mm	4.0 mm

TORX® screwdrivers 267PR "MagicSpring" PicoFinish



The "Magic Spring" retaining spring holds TORX® screws tight.

dpvlink 9180



Article	Tip	Shank	Diameter
267PR.TX06x40	TX06	40 mm	2.5 mm
267PR.TX07x40	TX07	40 mm	2.5 mm
267PR.TX08x40	TX08	40 mm	2.5 mm
267PR.TX09x50	TX09	50 mm	3.0 mm
267PR.TX10x50	TX10	50 mm	3.0 mm
267PR.TX15x60	TX15	60 mm	3.5 mm

Wiha PicoFinish socket wrench sets



dpvlink 9285



Article	Type
265P.K6	Hexagon socket wrench set, 6-piece 265P.60x2.5, 60 x 3.0, 60 x 3.5, 60 x 4.0, 60 x 5.0, 60 x 5.5

Wiha PicoFinish screwdriver sets



dpvlink 9274



Article	Type
260P.K6	Slotted/Phillips screwdriver set, 6-piece 260P.40x1.5, 40 x 2.0, 50 x 2.5, 50 x 3.0 261P.PH00x40, PH0x50
260P.K7	Slotted/Phillips screwdriver set 7-piece 260P.40x1.5, 40 x 2.0, 50 x 2.5, 50 x 3.0 261P.PH00x40, PH0x50, PH1x60 (without plastic holder)

Wiha PicoFinish screwdriver sets



dpvlink 9280



Article	Type
267PR.K6	TORX® screwdriver set "MagicSpring", 6-piece 267PR.TX06x40, TX07x40, TX08x40, TX09x50, TX10x50, TX15x60
267P.K6M	TORX® screwdriver set, 6-piece 267P.TX04x40, TX05x40, TX06x40, TX07x40, TX08x40, TX09x50
267P.K6	TORX® screwdriver set, 6-piece 267P.TX07x40, TX08x40, TX09x50, TX10x50, TX15x60, TX20x60
264P.K6	Hexagon ballpoint screwdriver set, 6-piece 264P.40x1.3, 50 x 1.5, 50 x 2.0, 60 x 2.5, 60 x 3.0 263P.40x0.9

WERA Screwdrivers



The Wera Black Point tip and an elaborate hardening process guarantee a **long durability**, an **increased corrosion protection** and **precise fitting accuracy**.

In compliance with the ESD standard DIN EN 61340-5-1 ⚠️

Micro-screwdriver 1550 ESD cross-tip



dpvlink 18078

Article	Tip	Handle length	Shank	Diameter
WE-1550ESD.PH00x60	PH00	97 mm	60 mm	2.5 mm
WE-1550ESD.PH0x60	PH0	97 mm	60 mm	3.0 mm
WE-1550ESD.PH1x80	PH1	97 mm	80 mm	4.0 mm

Micro-screwdriver 1555 ESD cross-tip Pozidriv



dpvlink 18087

Article	Tip	Handle length	Shank	Diameter
WE-1555ESD.PZ0x60	PZ0	97 mm	60 mm	3.0 mm
WE-1555ESD.PZ1x80	PZ1	97 mm	80 mm	4.0 mm

Micro-screwdriver 1567 ESD TORX



dpvlink 18102

Article	Tip	Handle length	Shank	Diameter
WE-1567ESD.TX4x40	TX4	97 mm	40 mm	2.5 mm
WE-1567ESD.TX5x40	TX5	97 mm	40 mm	3.0 mm
WE-1567ESD.TX6x40	TX6	97 mm	40 mm	3.0 mm

Slotted micro-screwdriver 1578A ESD



dpvlink 18106

Article	Tip	Handle length	Shank	Diameter
WE-1578A-ESD1.2x40	1.2 mm	97 mm	40 mm	2.5 mm
WE-1578A-ESD1.5x40	1.5 mm	97 mm	40 mm	2.5 mm
WE-1578A-ESD1.8x60	1.8 mm	97 mm	60 mm	2.5 mm
WE-1578A-ESD2.0x60	2.0 mm	97 mm	60 mm	2.5 mm
WE-1578A-ESD2.5x80	2.5 mm	97 mm	80 mm	2.5 mm
WE-1578A-ESD3.0x80	3.0 mm	97 mm	80 mm	3.0 mm
WE-1578A-ESD3.5x80	3.5 mm	97 mm	80 mm	4.0 mm
WE-1578A-ESD4.0x80	4.0 mm	97 mm	80 mm	4.0 mm

Micro-screwdriver 1569 ESD socket wrench



dpvlink 18122

Article	Tip	Handle length	Shank	Diameter
WE-1569ESD.SW5.0x60	SW5.0	97 mm	60 mm	7.0 mm
WE-1569ESD.SW5.5x60	SW5.5	97 mm	60 mm	7.8 mm

Electronic screwdriver set 1578A/6 ESD



Electronic screwdriver set 1578A/6 ESD, 6-piece set + Rack

dpvlink 18125

Article	Type
WE-1578A/6-ESD	Electronic screwdriver set 6-pcs 1578A-ESD1.2x40/ ESD1.5x40/ ESD1.8x60/ ESD2.5x80 1550ESD.PH0x60; 1550ESD.PH1x80

Torque screwdrivers ESD WERA

Wera 1460 Micro Torque Screwdriver ESD



Micro Torque screwdriver 1460-ESD

- suitable for bits with 4 mm Halfmoon drive (Wera series 9) and 4 mm HIOS-drive (Wera series 21)
- quick-change chuck for lightning bit change
- preset torque 0.035 Nm
- adjustable 0.02 - 0.06 Nm
- accuracy +/- 10%
- Handle: Kraftform Micro with roll protection and revolving cap

In compliance with the ESD standard DIN EN 61340-5-1 ⚠

dpvlink 18128

Article	Range
WE-1460ESD ESD Micro Torque Screwdriver	0.02 - 0.06 Nm



Wera 7400 series Torque Screwdriver ESD



Torque screwdriver series 7400-ESD

- suitable for bits with 1/4" hexagon drive and Wera drive series 1 and 4
- Rapidaptor technologie with rapid-in, rapid-out, rapid-spin, chuck-all and single-hand-function
- nonmagnetic design
- accuracy +/- 6%
- Handle: Kraftform with roll protection

In compliance with the ESD standard DIN EN 61340-5-1 ⚠

dpvlink 18130

Article	Range
WE-7440ESD Torque Screwdriver 7440-ESD	0.3 - 1.2 Nm
WE-7441ESD Torque Screwdriver 7441-ESD	1.2 - 3.0 Nm



WERA Bit holder / Bits

WERA 811/1 Bit holder ESD Stubby



Stubby bit holder 811/1 ESD, short design

- suitable for 1/4" bits according to DIN 3126-C 6,3 and Wera drive series 1
- Blade: hexagon
- Design: 1/4" - hexagon socket with snap ring, chrome-plated
- Handle: Kraftform with roll protection

In compliance with the ESD standard DIN EN 61340-5-1 ⚠

dpvlink 18137

Article	Type	Handle length
WE-811/1-ESD	811/1 Stubby bit holder, magnetic	54 mm



WERA 813 R Bit holder ESD



Bit holder 813 R ESD

- suitable for bits mit 1/4" - hexagon drive according to DIN 3126-C and Wera drive series 1 + 4
- Design: 1/4" - hexagon socket with Wera quick-change chuck and Rapidaptor technology with rapid-in, rapid-out, rapid-spin, chuck-all and single-hand function
- Handle: Kraftform with roll protection

In compliance with the ESD standard DIN EN 61340-5-1 ⚠

dpvlink 18139

Article	Handle length
WE-813R-ESD 813 R Bit holder	90 mm



WERA 816 R Bit holder ESD



Bits holder 816 R ESD

- suitable for bits with 1/4" - hexagon drive according to DIN 3126-C and Wera drive series 1 + 4
- Design: 1/4" - hexagon socket with Wera quick-change chuck and Rapidaptor technology with rapid-in, rapid-out, rapid-spin, chuck-all and single-hand-function
- Handle: Kraftform with roll protection

In compliance with the ESD standard DIN EN 61340-5-1 ⚠

dpvlink 18141

Article	Handle length
WE-816R-ESD 816 R Bit holder	119 mm



WERA 1013 Micro Bit holder ESD



Micro Bit holder 1013-ESD

- suitable for bits with 4 mm Halfmoon drive (Wera series 9) and 4 mm HIOS drive (Wera series 21)
- with quick-change chuck for lightning bit change
- Handle: Kraftform Micro with roll protection and revolving cap

In compliance with the ESD standard DIN EN 61340-5-1 ⚠

dpvlink 18133

Article	Handle length
WE-1013ESD 1013 Micro Bit holder	97 mm



WERA Slot Bit 800/9C



Drive: 4mm Halfmoon
Design: hard

dpvlink 18145

Article	Tip	Thickness	Shank
WE-800/9C-1.5x44	1.5 mm	0.23 mm	44 mm
WE-800/9C-2.0x44	2.0 mm	0.4 mm	44 mm
WE-800/9C-3.0x44	3.0 mm	0.5 mm	44 mm



WERA Hex-Plus-Bit 840/9C



Drive: 4mm Halfmoon
Design: hard

dpvlink 18150

Article	Size	Shank
WE-840/9C-SW1.5x44	1.5 mm	44 mm
WE-840/9C-SW2.0x44	2.0 mm	44 mm



further bits available on request

WERA Bit 851/9 JCIS



Drive: 4mm Halfmoon
Design: hard

dpvlink 18153

Article	Tip	Thickness	Shank
WE-851/9-1.8PH00x44	PH00	1.8 mm	44 mm
WE-851/9-1.8PH00x64	PH00	1.8 mm	64 mm
WE-851/9-1.8PH0x44	PH0	1.8 mm	44 mm
WE-851/9-1.8PH0x64	PH0	1.8 mm	64 mm
WE-851/9-2.0PH0x44	PH0	2.0 mm	44 mm
WE-851/9-2.2PH0x64	PH0	2.2 mm	64 mm
WE-851/9-3.0PH1x44	PH1	3.0 mm	44 mm
WE-851/9-3.0PH1x64	PH1	3.0 mm	64 mm



WERA IP TORX-Plus Bit 867/9C



Drive: 4mm Halfmoon
Design: hard

dpvlink 18163

Article	Tip	Thickness	Shank
WE-867/9C.1IPx44	1IP	1.5 mm	44 mm
WE-867/9C.2IPx44	2IP	1.5 mm	44 mm
WE-867/9C.3IPx44	3IP	1.7 mm	44 mm
WE-867/9C.4IPx44	4IP	2.0 mm	44 mm
WE-867/9C.4IPx64	4IP	2.0 mm	64 mm
WE-867/9C.5IPx44	5IP	2.0 mm	44 mm
WE-867/9C.5IPx70	5IP	3.0 mm	70 mm
WE-867/9C.6IPx44	6IP	2.25 mm	44 mm
WE-867/9C.8IPx44	8IP	3.0 mm	44 mm
WE-867/9C.8IPx70	8IP	3.0 mm	70 mm
WE-867/9C.10IPx44	10IP	3.0 mm	44 mm



WERA TORX Bit 867/9C



Drive: 4mm Halfmoon
Design: hard

dpvlink 18175

Article	Tip	Thickness	Shank
WE-867/9C.TX1x44	TX1	1.5 mm	44 mm
WE-867/9C.TX2x44	TX2	1.5 mm	44 mm
WE-867/9C.TX3x44	TX3	1.7 mm	44 mm
WE-867/9C.TX4x44	TX4	1.8 mm	44 mm
WE-867/9C.TX4x64	TX4	2.0 mm	64 mm
WE-867/9C.TX5x44	TX5	3.0 mm	44 mm
WE-867/9C.TX5x64	TX5	2.0 mm	64 mm
WE-867/9C.TX6x44	TX6	3.0 mm	44 mm
WE-867/9C.TX6x64	TX6	2.0 mm	64 mm
WE-867/9C.TX7x64	TX7	2.3 mm	64 mm
WE-867/9C.TX8x44	TX8	3.0 mm	44 mm
WE-867/9C.TX8x64	TX8	3.0 mm	64 mm



WERA Kraftform Kompakt Micro-Set 1013ESD/11SB



dpvlink 18188

Article	Type
WE-1013ESD/11SB	WERA KK Micro-Set 1013ESD/11SB Micro bit holder WE-1013ESD, PH 00, PH 0, PH 1, TORX: TX 5, TX6 Slot: 0.23 x 1.5 / 0.4 x 2.0 / 0.5 x 3.0 Hex-Plus: 1.5 / 2.0



WERA Kraftform Kompakt Micro-Set 1013ESD/20SB



dpvlink 18192

Article	Type
WE-1013ESD/20SB	WERA KK Micro-Set 1013ESD/20SB Micro bit holder WE-1013ESD, PH 00, PH 0, PH 1, TORX: TX1, TX2, TX3, TX4, TX 5, TX6 TORX PLUS: 1 IP, 2 IP, 3 IP, 4 IP Slot: 0.23 x 1.5 / 0.4 x 2.0 / 0.5 x 3.0 Hex-Plus: 1.5 / 2.0 Five Lobe: # 1



Wera Kraftform compact set Stubby 811/1 ESD/10



dpvlink 25155

Article	Type
WE-811/1-ESD/10	Wera Kraftform compact set Stubby 811/1 ESD/10 Micro bit holder WE-811/1-ESD, PH00, PH 0, PH 1, PH2 Slotted: 0.5 x 3 / 0.6 x 4.5 / 1 x 5.5 / 1.2 x 6.5 / 1.2 x 8



Wera Kraftform Compact set 816R ESD/60



dpvlink 25157

Article	Type
WE-816R-ESD/60	Wera Kraftform Compact set 816R ESD/60 Micro bit holder WE-816R-ESD, PH 1, PH 2, PH 3, TORX: TX10, TX15, TX20, TX25, TX 30, Pozidriv: PZ1, PZ2, PZ3 Slotted: 1 x 5.5 Hex-Plus: 3 / 4 / 5 / 6 Five Lobe: # 1



Wera Kraftform Kompakt Micro set 1013ESD/21SB



dpvlink 25159

Article	Type
WE-1013ESD/21SB	Wera Kraftform Kompakt Micro set 1013ESD/21SB Micro bit holder WE-1013ESD, PH 000, PH00, PH 0, TORX: TX1, TX2, TX3, TX4, TX5, TORX PLUS: 1 IP, 2 IP, 3 IP, 4 IP, 11PR Microstix shape A: m / 00 / F / 0 Slotted : 0.23 x 1.5 / 0.35 x 2.5 Wrench socket: 2.5



Bit inserts



All offered bits have a socket fulfilling DIN 3126 ISO 1173 shape E 6.3

Material: High-quality chrome-vanadium steel, completely hardened.

Slotted bit / shape E 6.3



dpvlink 6460

Article	Tip	Thickness	L [mm]
7040Z.50x3.0x0.5	3.0 mm	0.5 mm	50 mm
7040Z.50x3.5x0.6	3.5 mm	0.6 mm	50 mm
7040Z.50x4.0x0.5	4.0 mm	0.5 mm	50 mm
7040Z.50x4.0x0.8	4.0 mm	0.8 mm	50 mm
7040Z.50x4.5x0.6	4.5 mm	0.6 mm	50 mm
7040Z.50x5.5x0.8	5.5 mm	0.8 mm	50 mm
7040Z.50x5.5x1.0	5.5 mm	1.0 mm	50 mm
7040Z.50x6.5x1.2	6.5 mm	1.2 mm	50 mm
7040Z.50x8.0x1.2	8.0 mm	1.2 mm	50 mm
7040Z.50x8.0x1.6	8.0 mm	1.6 mm	50 mm



Phillips bit / shape E 6.3



dpvlink 6469

Article	Tip	L [mm]
7041Z.PH0x70	PH0	70 mm
7041Z.PH1x70	PH1	70 mm
7041Z.PH1x90	PH1	90 mm
7041Z.PH1x110	PH1	110 mm
7041Z.PH1x127	PH1	127 mm
7041Z.PH1x150	PH1	150 mm
7041Z.PH2x70	PH2	70 mm
7041Z.PH2x90	PH2	90 mm
7041Z.PH2x110	PH2	110 mm
7041Z.PH2x127	PH2	127 mm
7041Z.PH2x150	PH2	150 mm
7041Z.PH3x70	PH3	70 mm
7041Z.PH3x90	PH3	90 mm
7041Z.PH3x110	PH3	110 mm
7041Z.PH3x127	PH3	127 mm
7041Z.PH3x150	PH3	150 mm



TORX® TR bit (Tamper-resistant) / shape E 6.3



with hole at the front

dpvlink 6544

Article	Tip	L [mm]
7045.TR07x50	TR07	50 mm
7045.TR08x50	TR08	50 mm
7045.TR09x50	TR09	50 mm
7045.TR10x50	TR10	50 mm
7045.TR15x50	TR15	50 mm
7045.TR20x50	TR20	50 mm
7045.TR25x50	TR25	50 mm
7045.TR27x50	TR27	50 mm
7045.TR30x50	TR30	50 mm
7045.TR40x50	TR40	50 mm



-TorxPlus bits and further versions available on request-

TORX® bit / shape E 6,3



dpvlink 6519



Article	Tip	L [mm]
7045.TX05x50	TX05	50 mm
7045.TX06x50	TX06	50 mm
7045.TX06x70	TX06	70 mm
7045.TX06x90	TX06	90 mm
7045.TX07x50	TX07	50 mm
7045.TX07x70	TX07	70 mm
7045.TX07x90	TX07	90 mm
7045.TX08x50	TX08	50 mm
7045.TX08x70	TX08	70 mm
7045.TX08x90	TX08	90 mm
7045.TX09x50	TX09	50 mm
7045.TX09x70	TX09	70 mm
7045.TX09x90	TX09	90 mm
7045.TX10x50	TX10	50 mm
7045.TX10x70	TX10	70 mm
7045.TX10x90	TX10	90 mm
7045.TX10x110	TX10	110 mm
7045.TX15x50	TX15	50 mm
7045.TX15x70	TX15	70 mm
7045.TX15x90	TX15	90 mm
7045.TX15x110	TX15	110 mm
7045.TX20x50	TX20	50 mm
7045.TX20x70	TX20	70 mm
7045.TX20x90	TX20	90 mm
7045.TX20x110	TX20	110 mm
7045.TX25x50	TX25	50 mm
7045.TX25x70	TX25	70 mm
7045.TX25x90	TX25	90 mm
7045.TX25x110	TX25	110 mm
7045.TX27x50	TX27	50 mm
7045.TX27x70	TX27	70 mm
7045.TX27x90	TX27	90 mm
7045.TX30x50	TX30	50 mm
7045.TX30x70	TX30	70 mm
7045.TX30x90	TX30	90 mm
7045.TX30x110	TX30	110 mm
7045.TX40x50	TX40	50 mm
7045.TX40x70	TX40	70 mm
7045.TX40x90	TX40	90 mm
7045.TX40x110	TX40	110 mm

Pozidriv bit / shape E 6.3



dpvlink 6487



Article	Tip	L [mm]
7042Z.PZ0x70	PZ0	70 mm
7042Z.PZ1x70	PZ1	70 mm
7042Z.PZ1x90	PZ1	90 mm
7042Z.PZ1x110	PZ1	110 mm
7042Z.PZ1x127	PZ1	127 mm
7042Z.PZ1x150	PZ1	150 mm
7042Z.PZ2x70	PZ2	70 mm
7042Z.PZ2x90	PZ2	90 mm
7042Z.PZ2x110	PZ2	110 mm
7042Z.PZ2x127	PZ2	127 mm
7042Z.PZ2x150	PZ2	150 mm
7042Z.PZ3x70	PZ3	70 mm
7042Z.PZ3x90	PZ3	90 mm
7042Z.PZ3x110	PZ3	110 mm
7042Z.PZ3x127	PZ3	127 mm
7042Z.PZ3x150	PZ3	150 mm

Standard bit slotted, shape C 6.3



Material: high-quality chrome-vanadium steel, completely hardened.

Drive: DIN 3126, ISO 1173 shape C 6.3.

Application: for all kinds of screw connections in trade and industry.

dpvlink 12772



Article	Tip	Thickness	L [mm]
7010Z.25x4.5x0.6	4.5 mm	0.6 mm	25 mm
7010Z.25x5.5x0.8	5.5 mm	0.7 mm	25 mm
7010ZL.39x4.0x0.5	4.0 mm	0.5 mm	39 mm
7010ZL.39x4.0x0.8	4.0 mm	0.8 mm	39 mm

Standard bit, Phillips, shape C 6.3



Material: high-quality chrome-vanadium steel, completely hardened.

Drive: DIN 3126, ISO 1173 shape C 6.3.

Application: for all kinds of screw connections in trade and industry.

dpvlink 12779



Article	Tip	L [mm]
7011Z.PH0x25	PH0	25 mm
7011Z.PH1x25	PH1	25 mm
7011Z.PH2x25	PH2	25 mm
7011Z.PH3x25	PH3	25 mm

Standard bit, Pozidriv, shape C 6.3



Material: high-quality chrome-vanadium steel, completely hardened.

Drive: DIN 3126, ISO 1173 type C 6.3.

Application: for all kinds of screw connections in trade and industry.

dpvlink 12784



Article	Tip	L [mm]
7012Z.PZ0x25	PZ0	25 mm
7012Z.PZ1x25	PZ1	25 mm
7012Z.PZ2x25	PZ2	25 mm
7012Z.PZ3x25	PZ3	25 mm

Standard bit, TORX®, shape C 6.3



Material: high-quality chrome-vanadium steel, completely hardened.

Drive: DIN 3126, ISO 1173 shape C 6.3.

Application: for all kinds of screw connections in trade and industry.

dpvlink 12789



Article	Tip	L [mm]
7015.TX03x25	T3	25 mm
7015.TX04x25	T4	25 mm
7015.TX05x25	T5	25 mm
7015.TX06x25	T6	25 mm
7015.TX07x25	T7	25 mm
7015.TX08x25	T8	25 mm
7015.TX09x25	T9	25 mm
7015.TX10x25	T10	25 mm

Standard bit, TORX PLUS®, shape C 6.3



Material: high-quality chrome-vanadium steel, completely hardened.
Application: for all kinds of screw connections in trade and industry.
Extra: reinforced profile cross section transfers approx. 25% more torque in comparison with a TORX® profile.

dpvlink 13269

Article	Tip	L [mm]
7016Z.04IPx25	4IP	25 mm
7016Z.05IPx25	5IP	25 mm
7016Z.06IPx25	6IP	25 mm
7016Z.07IPx25	7IP	25 mm
7016Z.08IPx25	8IP	25 mm
7016Z.09IPx25	9IP	25 mm
7016Z.10IPx25	10IP	25 mm

Standard bit, hexagon, shape C 6.3

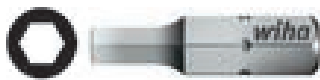

Material: High-quality chrome-vanadium steel, completely hardened.
Drive: DIN 3126, ISO 1173 type C 6.3.
Application: For all kinds of screw connections in trade and industry.

dpvlink 12798

Article	Size	L [mm]
7013Z.25x1.5	1.5 mm	25 mm
7013Z.25x2.0	2.0 mm	25 mm
7013Z.25x2.5	2.5 mm	25 mm
7013Z.25x3.0	3.0 mm	25 mm
7013Z.25x4.0	4.0 mm	25 mm
7013Z.25x5.0	5.0 mm	25 mm

Hexagon socket bit / shape E 6.3



dpvlink 6503

Article	Size	L [mm]
7043Z.50x1.5	1.5 mm	50 mm
7043Z.50x2.0	2.0 mm	50 mm
7043Z.50x3.0	3.0 mm	50 mm
7043Z.50x4.0	4.0 mm	50 mm
7043Z.50x5.0	5.0 mm	50 mm
7043Z.50x6.0	6.0 mm	50 mm
7043Z.50x8.0	8.0 mm	50 mm

Hexagon socket bit "MagicRing" / shape E 6.3



The MagicRing made of spring steel holds all standard screws tight in every situation.

dpvlink 6658

Article	Size	L [mm]
7043RZ.50x3.0	3.0 mm	50 mm
7043RZ.50x4.0	4.0 mm	50 mm
7043RZ.50x5.0	5.0 mm	50 mm
7043RZ.50x6.0	6.0 mm	50 mm

Hexagon socket ballpoint bit "MagicRing"



The "MagicRing" made of spring steel holds all standard screws tight in every situation.

dpvlink 6667

Article	Size	L [mm]
7047RZ.50x3.0	3.0 mm	50 mm
7047RZ.50x4.0	4.0 mm	50 mm
7047RZ.50x5.0	5.0 mm	50 mm
7047RZ.50x6.0	6.0 mm	50 mm

further bits available on request

Hexagon head bit / shape E 6.3



Standard bit, socket wrench insert, shape E 6.3
 High-quality chrome-vanadium steel, completely hardened

Article 7044M.SWxx = permanent magnet for a reliable hold of the screws

dpvlink 6510

Article	Size	L [mm]
7044.SW5.0	5.0 mm	55 mm
7044.SW5.5	5.5 mm	55 mm
7044.SW6.0	6.0 mm	55 mm
7044.SW7.0	7.0 mm	55 mm
7044.SW8.0	8.0 mm	55 mm
7044.SW10.0	10.0 mm	55 mm
7044.SW13.0	13.0 mm	55 mm
7044M.SW5.0	5.0 mm	55 mm
7044M.SW5.5	5.5 mm	55 mm
7044M.SW6.0	6.0 mm	55 mm
7044M.SW7.0	7.0 mm	55 mm
7044M.SW8.0	8.0 mm	55 mm
7044M.SW10.0	10.0 mm	55 mm
7044M.SW13.0	13.0 mm	55 mm

Quick-release holder type E 6.3



ClcFix quick-release holder, magnetic type E 6.3

Sleeve: Aluminium anodized
 Output: DIN 3126, ISO 1173 shape D 6.3
 Drive: DIN 3126, ISO 1173 shape E 6.3
 Extra: True one-hand operation for fast bit exchanges

dpvlink 6577

Article	Type
7149	ClcFix 1/4", magnetic

Bit holder 1/4" hexagon / shape E 6.3



dpvlink 6575

Article	Type
7113.S	Magnetic bit holder 1/4", length 59 mm
7113	Magnetic bit holder 1/4", length 74 mm
7143	Magnetic bit holder 1/4", with snap ring, length 72 mm
7140	Bit holder 1/4", with snap ring, length 57 mm

MicroBit-Set 65-piece



Content

45 Micro bits - drive 4 mm
 16 Micro socket wrench- drive 4 mm
 1 ESD fine screwdriver handle
 1 bit holder/extension 100 mm
 1 adapter from 4 mm hexagon to 1/4" hexagon
 1 bit ratchet 1/4"

ESD fine screwdriver handle

Extension 100 mm

Bit ratchet 1/4"

Adapter 1/4" - 4 mm

Philips 28 mm

000 / 00 / 0 / 1



Slotted 28 mm

0.8 / 1.2 / 1.5 / 1.8 / 2.0 / 2.5 / 3.0 / 3.5 / 4.0

Hexagon 28 mm

0.7 / 0.9 / 1.3 / 1.5 / 2.0 / 2.5 / 3.0 / 4.0

0.050" / 1/16" / 5/64" / 3/32" / 7/64" / 1/8" / 9/64" / 5/32"

TORX® 28 mm

T3 / T4 / T5 / T6 / T7 / T8 / T9 / T10 / T15 / T20

Pentalobe 28 mm

P1 / P2 / P3 / P4 / P5 / P6

Socket wrench 30 mm

2.0 / 2.5 / 3.0 / 3.5 / 4.0 / 4.5 / 5.0 / 5.5

5/64" / 3/32" / 7/64" / 1/8" / 9/64" / 5/32" / 3/16" / 7/32"

dpvlink 18607

Article Type

7000SK65ESD **MicroBit-Set 65-piece**



Torque screwdrivers ESD

Wiha TorqueVario®-S ESD torque handle



For a controlled screwing of electrostatically susceptible components with a given torque in combination with a Wiha Torque ESD exchangeable blade.

- Variable torque adjustment
- Torque is adjustable with an adjusting tool (torque setter, included in the scope of delivery)
- Numerical torque display in window scale
- Ergonomic multi-component handle made of electrostatically dissipative plastic
 Surface resistance $R_s = 10^6 - 10^9 \text{ ohm}$ ⚡
- Handle size is optimally adapted to the torque range
- Blades are printed with the permissible maximum torque
- Blades are coated with electrostatically dissipative plastic
- Click indicates when the set torque value has been reached
- Accuracy $\pm 6\%$ (model 2882ESD.TV1 $\pm 10\%$)

In order to protect the screw and the tool from damage during closing and releasing, the torque screwdrivers are equipped with a function for limiting the closure torque as well as for limiting the release torque. When releasing the screw, a controlled torque is applied which is approx. 50% higher than the closure torque.

Quality

The mechanical components of torque screwdrivers provide a repeatability going far beyond the required standard, even during continuous use. For your safety, before delivery, each tool is checked with a specially designed calibration and marking system, and the results are documented.

Standards:

DIN EN 61340-5-1/61340-5-2, EN ISO 6789, BS EN 26789, ASME B107.14M

dpvlink 6432

Article	Type	Range
2882ESD.TV0	ESD torque handle TV0	0.04 - 0.46 Nm
2882ESD.TV1	ESD torque handle TV1	0.1 - 0.6 Nm
2882ESD.TV1-6	ESD torque handle TV1	0.1 - 0.6 Nm
2882ESD.TV2	ESD torque handle TV2	0.4 - 1.0 Nm
2882ESD.TV3	ESD torque handle TV3	0.5 - 2.0 Nm
2882ESD.TV4	ESD torque handle TV4	1.0 - 5.0 Nm



Torque screwdrivers VDE

Wiha TorqueVario®-S VDE torque handle



For a controlled screwing on live parts with a given torque, in combination with a slimTorque VDE holder for 6 mm slimBits.

- Variable torque adjustment
- Torque is steplessly adjustable using an adjusting tool
- Numerical torque display in window scale
- Ergonomic multi-component handle with protective insulation 1000 V AC, GS tested
- Handle size is optimally adapted to the torque range
- Click indicates when the set torque value has been reached
- Accuracy ±6%
- The protective insulation is directly sprayed onto the bit and completely integrated into the bit

Scope of delivery:

- 1x torque screwdriver TorqueVario®-S electric
- slimTorque VDE bit holder for 6 mm slimBits
- 1x adjusting tool for torque screwdriver with long handle

Standards:

type tested up to 10000 V, IEC 60900, DIN EN ISO 6789

dpvlink 9370



Article	Type	Range	
2872.TV3	Torque handle TV 3 VDE	0.5 - 2.0 Nm	
2872.TV4	Torque handle TV 4 VDE	0.8 - 5.0 Nm	
2872.TV5	Torque handle TV 5 VDE	2.0 - 7.0 Nm	

Wiha slimBit slotted - exchangeable blade VDE



For all work on live components up to 1,000 V AC. Tested according to IEC 60900. 6 mm slimBits only to be used in the slimVario® bit holder and slimTorque VDE bit holder (VDE torque system).

dpvlink 21968



Article	Nm					
	max. Nm	Width	Thickness	Diameter		
2831VDE.25	0.4 Nm	2.5 mm	0.4 mm	6.0 mm		
2831VDE.30	0.6 Nm	3.0 mm	0.5 mm	6.0 mm		
2831VDE.35	2.5 Nm	3.5 mm	0.6 mm	6.0 mm		
2831VDE.40	2.5 Nm	4.0 mm	0.8 mm	6.0 mm		
2831VDE.55	5.5 Nm	5.5 mm	1.0 mm	6.0 mm		
2831VDE.65	5.5 Nm	6.5 mm	1.2 mm	6.0 mm		

Wiha slimBit Phillips - exchangeable blade VDE



For all work on live components up to 1,000 V AC. Tested according to IEC 60900. 6 mm slimBits only to be used in the slimVario® bit holder and slimTorque VDE bit holder (VDE torque system).

dpvlink 21975



Article		Nm			
	Tip	max. Nm	Diameter		
2831VDE.PH1	PH1	3.8 Nm	6.0 mm		
2831VDE.PH2	PH2	5.5 Nm	6.0 mm		

Wiha slimBit Pozidriv - exchangeable blade VDE



For all work on live components up to 1,000 V AC. Tested according to IEC 60900. 6 mm slimBits only to be used in the slimVario® bit holder and slimTorque VDE bit holder (VDE torque system).

dpvlink 21978



Article		Nm			
	Tip	max. Nm	Diameter		
2831VDE.PZ1	PZ1	3.8	6.0		
2831VDE.PZ2	PZ2	5.5	6.0		

Wiha slimBit slotted/Phillips - exchangeable blade VDE



For all work on live components up to 1,000 V AC. Tested according to IEC 60900. 6 mm slimBits only to be used in the slimVario® bit holder and slimTorque VDE bit holder (VDE torque system).

dpvlink 21981



Article		Nm			
	Tip	max. Nm	Diameter		
2831VDE.SL-PH1	SL/PH1	3.8	6.0		
2831VDE.SL-PH2	SL/PH2	5.5	6.0		

Wiha slimBit slotted/Pozidriv - exchangeable blade VDE



For all work on live components up to 1,000 V AC. Tested according to IEC 60900. 6 mm slimBits only to be used in the slimVario® bit holder and slimTorque VDE bit holder (VDE torque system).

dpvlink 21984



Article		Nm			
	Tip	max. Nm	Diameter		
2831VDE.SL-PZ1	SL/PZ1	3.8	6.0		
2831VDE.SL-PZ2	SL/PZ2	3.8	6.0		

Wiha Torque TORX® exchangeable blade VDE



High-quality chrome-vanadium-molybdenum steel, completely hardened, burnished. Protective insulation directly sprayed onto the blade. Manufactured according to DIN EN 60900 (IEC 900), individually tested to 10,000 V

dpvlink 20126

Article		Nm			
	Tip	max. Nm	Diameter		
2831VDE.T8	T8	1.3	6.0		
2831VDE.T9	T9	1.3	6.0		
2831VDE.T10	T10	3.8	6.0		
2831VDE.T15	T15	5.0	6.0		
2831VDE.T20	T20	5.5	6.0		
2831VDE.T25	T25	5.5	6.0		

Torque screwdrivers

Wiha slimBit hexagon - exchangeable blade VDE



For all work on live components up to 1,000 V AC. Tested according to IEC 60900. 6 mm slimBits only to be used in the slimVario® bit holder and slimTorque VDE bit holder (VDE torque system).

dpvlink 21988

Article	Tip	Nm		Diameter
		max. Nm		
2831VDE.SK15	1.5	0.9		6.0
2831VDE.SK20	2	1.8		6.0
2831VDE.SK25	2.5	3.8		6.0
2831VDE.SK30	3	5.5		6.0
2831VDE.SK40	4	5.5		6.0
2831VDE.SK50	5	5.5		6.0
2831VDE.SK60	6	5.5		6.0

Wiha slimBit square - exchangeable blade VDE



For all work on live components up to 1,000 V AC. Tested according to IEC 60900. 6 mm slimBits only to be used in the slimVario® bit holder and slimTorque VDE bit holder (VDE torque system).

dpvlink 21996

Article	Tip	Nm		Diameter
		max. Nm		
2831VDE.R1	#1	5.5		6.0
2831VDE.R2	#2	5.5		6.0

Wiha TorqueVario®-S VDE torque set



5-pcs torque screwdriver set Torque. Controlled fastening on live parts up to 1,000 V AC. VDE torque handle steplessly adjustable with Torque Setter adjusting tool (included in the scope of delivery) from 1.0 - 5.0 Nm. Protective insulation molded directly onto the bit and completely integrated into the bit in the lower area.

Scope of delivery:

- 1x torque screwdriver TorqueVario-S electric with variably adjustable torque limit, tool tested at 10,000 V AC and approved for 1,000 V AC / 0.8 - 5.0 Nm
- 1x slimBit holder electric, locked mechanically for VDE torque screwdriver with long handle
- 1x adjusting tool for torque screwdriver with long handle
- 1x SL/PZ1
- 1x SL/PZ2

Standards:

type-tested up to 10000 V, IEC 60900, DIN EN ISO 6789

dpvlink 21959

Article	Ausführung	Bereich [Nm]
2872.TV.SET	Torque screwdriver TV set VDE, 5-piece	0.8-5.0

Torque screwdrivers

Wiha TorqueVario®-S torque handle



For a controlled screwing at a given torque, in combination with a Wiha Torque exchangeable blade.

- Variable torque adjustment
- Torque is adjustable using an adjusting tool (torque-setter, included in the scope of delivery)
- Numerical torque display in window scale
- Ergonomic multi-component handle, extremely handy due to light and compact design
- Handle size is optimally adapted to the torque range
- Blades are printed with the permitted maximum torque
- Blades are color-coded
- Click indicates when the set torque value has been reached
- Accuracy $\pm 6\%$ (model 2852.TV1 $\pm 10\%$)

Standards:

EN ISO 6789, BS EN 26789, ASME B107.14M

dpvlink 9295

Article	Type	Range
2852.TV1	Torque handle TV1	0.1 - 0.6 Nm
2852.TV2	Torque handle TV2	0.4 - 1.0 Nm
2852.TV3	Torque handle TV3	0.8 - 2.0 Nm
2852.TV4	Torque handle TV4	1.0 - 5.0 Nm
2852.TV5	Torque handle TV5	2.0 - 8.0 Nm

Wiha Torque slotted exchangeable blade



High-quality chrome-vanadium-molybdenum steel, completely hardened, matt chrome-plated. Wiha ChromTop® blade tip guarantees highest dimensional accuracy. Color coding: grey.

DIN 5264, ISO 2380.

dpvlink 9313

Article	Nm max. Nm	Tip Thickness		Ø
2859.15	0.15 Nm	1.5 mm	0.25 mm	4.0 mm
2859.20	0.4 Nm	2.0 mm	0.4 mm	4.0 mm
2859.25	0.4 Nm	2.5 mm	0.4 mm	4.0 mm
2859.30	0.6 Nm	3.0 mm	0.5 mm	4.0 mm
2859.35	1.1 Nm	3.5 mm	0.6 mm	4.0 mm
2859.40	1.1 Nm	4.0 mm	0.8 mm	4.0 mm

Wiha Torque Phillips exchangeable blade



High-quality chrome-vanadium-molybdenum steel, completely hardened, matt chrome-plated. Wiha ChromTop® blade tip guarantees highest dimensional accuracy. Color coding: dark blue.

DIN ISO 8764-1

dpvlink 9320

Article	Tip	Nm		Ø
		max. Nm		
2859.PH000	PH000	0.4 Nm		4.0 mm
2859.PH00	PH00	0.4 Nm		4.0 mm
2859.PH0	PH0	0.9 Nm		4.0 mm
2859.PH1	PH1	3.8 Nm		4.0 mm
2859.PH2	PH2	5.5 Nm		4.0 mm

Wiha Torque Pozidriv exchangeable blade



High-quality chrome-vanadium-molybdenum steel, completely hardened, matt chrome-plated. Wiha ChromTop® blade tip guarantees highest dimensional accuracy. Color coding: light blue.

DIN ISO 8764-1

dpvlink 9327

Article	Tip	Nm max. Nm	Ø
2859.PZ0	PZ0	0.9 Nm	4.0 mm
2859.PZ1	PZ1	3.8 Nm	4.0 mm
2859.PZ2	PZ2	5.5 Nm	4.0 mm



Wiha Torque hexagon exchangeable blade



High-quality chrome-vanadium-molybdenum steel, completely hardened, matt chrome-plated. Wiha ChromTop® blade tip guarantees highest dimensional accuracy. Color coding: red.

dpvlink 9331

Article	Nm max. Nm	Tip	Ø
2859.SK15	0.9 Nm	1.5 mm	4.0 mm
2859.SK20	1.8 Nm	2.0 mm	4.0 mm
2859.SK25	3.8 Nm	2.5 mm	4.0 mm
2859.SK30	5.5 Nm	3.0 mm	4.0 mm
2859.SK40	8.0 Nm	4.0 mm	4.0 mm



Wiha Torque hexagon ballpoint exchangeable blade



High-quality chrome-vanadium-molybdenum steel, completely hardened, matt chrome-plated. Wiha ChromTop® blade tip guarantees highest dimensional accuracy. Color coding: red. The ballpoint allows the screwing at an angle up to 25°.

dpvlink 9337

Article	Nm max. Nm	Tip	Ø
2859.SKK15	0.4 Nm	1.5 mm	4.0 mm
2859.SKK20	0.9 Nm	2.0 mm	4.0 mm
2859.SKK25	2.0 Nm	2.5 mm	4.0 mm
2859.SKK30	3.8 Nm	3.0 mm	4.0 mm
2859.SKK40	8.0 Nm	4.0 mm	4.0 mm



Wiha Torque TORX® exchangeable blade



High-quality chrome-vanadium-molybdenum steel, completely hardened, matt chrome-plated. Wiha ChromTop® blade tip guarantees highest dimensional accuracy. Color coding: dark green.

dpvlink 9343

Article	Tip	Nm max. Nm	Ø
2859.TX05	TX05	0.4 Nm	4.0 mm
2859.TX06	TX06	0.6 Nm	4.0 mm
2859.TX07	TX07	0.9 Nm	4.0 mm
2859.TX08	TX08	1.3 Nm	4.0 mm
2859.TX09	TX09	2.5 Nm	4.0 mm
2859.TX10	TX10	3.8 Nm	4.0 mm
2859.TX15	TX15	5.5 Nm	4.0 mm
2859.TX20	TX20	8.0 Nm	4.0 mm
2859.TX25	TX25	8.0 Nm	4.0 mm



Wiha Torque TORX® "MagicSpring" exchangeable blade



High-quality chrome-vanadium-molybdenum steel, completely hardened, matt chrome-plated. Wiha ChromTop® blade tip guarantees highest dimensional accuracy. Color coding: dark green. The "MagicSpring" retaining spring holds TORX® screws tight.

dpvlink 9361

Article	Tip	Nm max. Nm	Ø
2859R.TX06	TX06	0.6 Nm	4.0 mm
2859R.TX07	TX07	0.9 Nm	4.0 mm
2859R.TX08	TX08	1.3 Nm	4.0 mm
2859R.TX09	TX09	2.5 Nm	4.0 mm
2859R.TX10	TX10	3.8 Nm	4.0 mm
2859R.TX15	TX15	5.5 Nm	4.0 mm
2859R.TX20	TX20	8.0 Nm	4.0 mm
2859R.TX25	TX25	8.0 Nm	4.0 mm



Wiha Torque TORX PLUS® exchangeable blade



High-quality chrome-vanadium-molybdenum steel, completely hardened, matt chrome-plated. Wiha ChromTop® blade tip guarantees highest dimensional accuracy. Color coding: light green.

dpvlink 9303

Article	Tip	Nm max. Nm	Ø
2859.05IP	05IP	0.5 Nm	4.0 mm
2859.06IP	06IP	0.8 Nm	4.0 mm
2859.07IP	07IP	1.3 Nm	4.0 mm
2859.08IP	08IP	2.0 Nm	4.0 mm
2859.09IP	09IP	3.0 Nm	4.0 mm
2859.10IP	10IP	4.5 Nm	4.0 mm
2859.15IP	15IP	6.6 Nm	4.0 mm
2859.20IP	20IP	8.0 Nm	4.0 mm
2859.25IP	25IP	8.0 Nm	4.0 mm



Wiha Torque TORX PLUS® "Magic Spring" exchangeable blade



High-quality chrome-vanadium-molybdenum steel, completely hardened, matt chrome-plated. Wiha ChromTop® blade tip guarantees highest dimensional accuracy. Color coding: light green. The "MagicSpring" retaining spring holds TORX PLUS® screws tight.

dpvlink 9352

Article	Tip	Nm max. Nm	Ø
2859R.06IP	06IP	0.8 Nm	4.0 mm
2859R.07IP	07IP	1.3 Nm	4.0 mm
2859R.08IP	08IP	2.0 Nm	4.0 mm
2859R.09IP	09IP	3.0 Nm	4.0 mm
2859R.10IP	10IP	4.5 Nm	4.0 mm
2859R.15IP	15IP	6.6 Nm	4.0 mm
2859R.20IP	20IP	8.0 Nm	4.0 mm
2859R.25IP	25IP	8.0 Nm	4.0 mm



Wiha Universal bit holder for TorqueVario-S



for all C 6.3 and E 6.3 bits, 1/4" socket

High-quality chrome-vanadium-molybdenum steel, completely hardened, matt chrome-plated, black plastic coating.

dpvlink 9301

Article	Type
2859	Universal bit holder for TorqueVario-S



Electric screwdrivers

Electric screwdrivers

Electric screwdrivers Kilews



For more than 30 years Kilews has been standing for quality in professional electric tools for manufacturing and assembly facilities. Meanwhile Kilews is one of the largest manufacturers in the world. Kilews was the first manufacturer to develop the brushless technology up to 35 Nm creating thereby the conditions to meet the increasing requirements in electronics manufacturing.

The brushless KILEWS low-voltage screwdrivers at a glance

- suitable for ESD: for sensitive components in electronics manufacturing
- suitable for cleanrooms: no ejection of carbon dust due to brushless technology
- durable: all screwdrivers have durable motors
- maintenance-free: the durable motors spare time-consuming waiting

All screwdrivers in ESD version with grounded bit.

Electric screwdrivers B 100 series

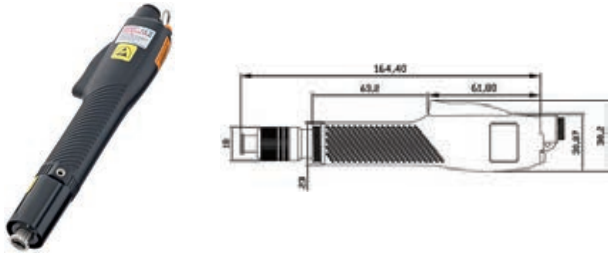

Low-voltage electric screwdrivers of the B 100 series are characterized by low weight and high stability. Due to a left-hand rotation button it is possible to change the direction of rotation quickly and without great effort. The brushless screwdrivers are easy to handle and at the same time very silent.

Technical data screwdriver:

Length: 165 mm
 Weight: 170 g
 Voltage / power: 12 VDC / 25 W
 Speed: 2
 Accuracy: ±3 %
 Bit type: C type wing shank 4 mm
 Suitable power supply unit: SKP-12HL

Model	SKD-B100L	SKD-B100LS4	SKD-B103L	SKD-B103LS4
Start type	lever start	lever start	lever start	lever start
Torque	0.008-0.14 Nm	0.008-0.14 Nm	0.05-0.343 Nm	0.05-0.343 Nm
Idle speed High	1000	280	1000	280
Idle speed Low	700	200	700	200
Screw size thread screw	1.0-1.7	1.0-1.7	1.0-2.3	1.0-1.7
Screw size self-tapping	1.0-1.5	1.0-1.5	1.0-2.0	1.0-2.0
Netzteil/Controller	SKP-12HL			

dpwlink 20208

Article	Type
SKD-B100L-ESD	SKD-B100L-ESD electric screwdriver incl. torque sleeve, without power supply unit SKP-12HL
SKD-B100LS4-ESD	SKD-B100LS4-ESD electric screwdriver incl. torque sleeve, without power supply unit SKP-12HL
SKD-B103L-ESD	SKD-B103L-ESD electric screwdriver incl. torque sleeve, without power supply unit SKP-12HL
SKD-B103LS4-ESD	SKD-B103LS4-ESD electric screwdriver incl. torque sleeve, without power supply unit SKP-12HL

Electric screwdrivers BN 200 series

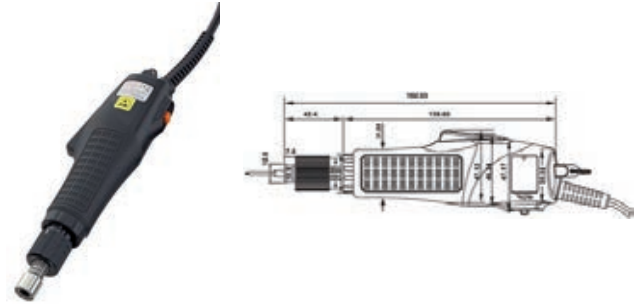

Due to its brushless technology the **low-voltage screwdriver of the BN 200 series** with lever start is suitable for cleanroom workplaces, as no carbon dust is ejected.

Technical data screwdriver:

Length: 230 mm
 Weight: 310 g
 Voltage / power: 32 VDC / 25 W
 Accuracy: ±3 %
 Bit type: B type 6.35 mm
 Power supply unit/Controller: see accessories

- Screw counting and soft start optionally available, not for SKD-BN203LS5
- 8 different speeds for SKD-BN203 available

Model	SKD-BN203L	SKD-BN203LS5	SKD-BN203LS6
Start type	lever start	lever start	lever start
Torque	0.02-0.34 Nm	0.02-0.34 Nm	0.02-0.34 Nm
Idle speed High	1000	500	370
Idle speed Low	700	350	260
Screw size thread screw	1.0-2.3	1.0-2.3	1.0-2.3
Screw size self-tapping	1.0-2.0	1.0-2.0	1.0-2.0
Power supply unit/Controller	SKP-32BC-60W		

Model	SKD-BN203LS7	SKD-BN207L	SKD-BN210L
Start type	lever start	lever start	lever start
Torque	0.02-0.34 Nm	0.05-0.69 Nm	0.05-0.69 Nm
Idle speed High	230	1000	1000
Idle speed Low	160	700	700
Screw size thread screw	1.0-2.3	1.4-2.6	1.4-2.6
Screw size self-tapping	1.0-2.0	1.4-2.3	1.6-2.6
Power supply unit/Controller	SKP-32BC-60W		

dpwlink 20302

Article	Type
SKD-BN203L-ESD	SKD-BN203L-ESD electric screwdriver lever start, 32V, without control unit
SKD-BN203LS5-ESD	SKD-BN203LS5-ESD electric screwdriver lever start, 32V, without control unit
SKD-BN203LS6-ESD	SKD-BN203LS6-ESD electric screwdriver lever start, 32V, without control unit
SKD-BN203LS7-ESD	SKD-BN203LS7-ESD electric screwdriver lever start, 32V, without control unit
SKD-BN207L-ESD	SKD-BN207L-ESD electric screwdriver lever start, 32V, without control unit
SKD-BN210L-ESD	SKD-BN210L-ESD electric screwdriver lever start, 32V, without control unit

Electric screwdriver BN 500 series

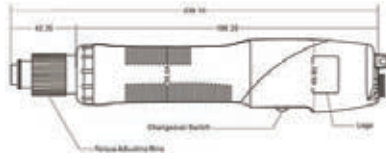

The maintenance-free **low-voltage screwdrivers of the BN 500 series** are suitable for cleanroom workplaces. Screw counting function and soft start are optionally available. Together with the soft start module a model equipped with left-hand thread with soft start in the left-hand rotation is also available.

Technical data screwdriver:

Length:	239 mm
Weight:	520 g
Voltage / power:	32 VDC / 55 W
Accuracy:	±3 %
Bit type:	B type 6.35 mm
Power supply unit/Controller:	see accessories

Model	SKD-BN512L	SKD-BN512LF	SKD-BN512LS
Start type	lever start	lever start high speed	lever start
Torque	0.15-1.18 Nm	0.15-1.18 Nm	0.15-1.18 Nm
Idle speed High	1000	2000	500
Idle speed Low	650	x	300
Screw size thread screw	1.6-3.0	1.6-3.0	x
Screw size self-tapping	1.6-2.6	1.6-2.6	x
Power supply unit/ Controller	SKP-32BC-60W, SKP-BE32HLN, SKP-BC40HLN		

Model	SKD-BN512P	SKD-BN512PF	SKD-BN517LF
Start type	push start	push start high speed	lever start high speed
Torque	0.15-1.18 Nm	0.15-1.18 Nm	0.29-1.67 Nm
Idle speed High	1000	2000	2000
Idle speed Low	650	x	x
Screw size thread screw	1.6-3.0	1.6-3.0	1.6-3.0
Screw size self-tapping	1.6-2.6	1.6-2.6	1.6-3.0
Power supply unit/ Controller	SKP-32BC-60W, SKP-BE32HL, SKP-BC40HLN		

Model	SKD-BN517PF	SKD-BN519L	SKD-BN519P
Start type	push start high speed	lever start	push start
Torque	0.29-1.67 Nm	0.29-1.86 Nm	0.29-1.86 Nm
Idle speed High	2000	1000	1000
Idle speed Low	x	650	650
Screw size thread screw	1.6-3.0	2.3-3.5	2.3-3.5
Screw size self-tapping	1.6-3.0	2.3-3.0	2.3-3.0
Power supply unit/ Controller	SKP-32BC-60W, SKP-BE32HL, SKP-BC40HLN		

dpvlink 20317



Article	Type
SKD-BN512L-ESD	SKD-BN512L-ESD electric screwdriver lever start, 32V, without control unit
SKD-BN512LF-ESD	SKD-BN512LF-ESD electric screwdriver lever start, high-speed, 32V, without control unit
SKD-BN512LS-ESD	SKD-BN512LS-ESD electric screwdriver lever start, 32V, without control unit
SKD-BN512P-ESD	SKD-BN512P-ESD electric screwdriver push start, 32V, without control unit
SKD-BN512PF-ESD	SKD-BN512PF-ESD electric screwdriver push start, high-speed, 32V, without control unit
SKD-BN517LF-ESD	SKD-BN517LF-ESD electric screwdriver lever start, high-speed, 32V, without control unit
SKD-BN517PF-ESD	SKD-BN517PF-ESD electric screwdriver push start, high-speed, 32V, without control unit
SKD-BN519L-ESD	SKD-BN519L-ESD electric screwdriver lever start, 32V, without control unit
SKD-BN519P-ESD	SKD-BN519P-ESD electric screwdriver push start, 32V, without control unit



All information about the Kilews electric screwdrivers can be found in the brochure available

- as flipping book
- as download
- as printed version

Electric screwdrivers

Electric screwdrivers BN 800 series

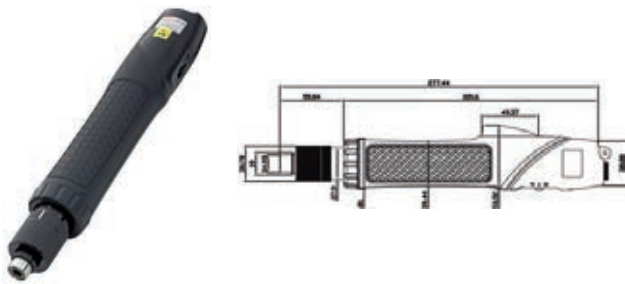

The maintenance-free **low-voltage screwdrivers of the BN 7000 and BN 800 series** achieve higher speeds along with lower heating. Screw counting function and soft start are optionally available. Together with the soft start module a model equipped with left-hand thread with soft start in the left-hand rotation is also available.

Technical data screwdriver:

Length:	278 mm
Weight:	800 g
Voltage / power:	32 VDC / 55 W
Accuracy:	±3 %
Bit type:	B type 6.35 mm
Power supply unit/Controller:	see accessories

Model	SKD-BN830L	SKD-BN830P	SKD-BN830LF
Start type	lever start	push start	lever start high-speed
Torque	0.98-2.94 Nm	0.98-2.94 Nm	0.98-2.94 Nm
Idle speed High	1000	1000	2000
Idle speed Low	700	700	1600
Screw size thread screw	2.6-4.0	2.6-4.0	2.6-4.0
Screw size self-tapping	2.6-3.5	2.6-3.5	2.6-3.5
Power control unit/Controller	SKP-40B-HLN		

Model	SKD-BN830PF	SKD-BN850L	SKD-BN850P
Start type	push start	lever start	push start
Torque	0.98-2.94 Nm	1.96-4.90 Nm	1.96-4.90 Nm
Idle speed High	2000	1000	1000
Idle speed Low	1600	700	700
Screw size thread screw	2.6-4.0	4.0-5.0	4.0-5.0
Screw size self-tapping	2.6-3.5	< 4	< 4
Power supply unit/Controller	SKP-40B-HLN		

dpvlink 20344

Article	Type	
SKD-BN830L-ESD	SKD-BN830L-ESD electric screwdriver lever start, 40V, without control unit	
SKD-BN830LF-ESD	SKD-BN830LF-ESD electric screwdriver lever start, high-speed, 40V, without control unit	
SKD-BN830P-ESD	SKD-BN830P-ESD electric screwdriver push start, 40V, without control unit	
SKD-BN830PF-ESD	SKD-BN830PF-ESD electric screwdriver push start, high-speed, 40V, without control unit	
SKD-BN850L-ESD	SKD-BN850L-ESD electric screwdriver lever start, 40V, without control unit	
SKD-BN850P-ESD	SKD-BN850P-ESD electric screwdriver push start, 40V, without control unit	

Electric screwdrivers BK 900 series

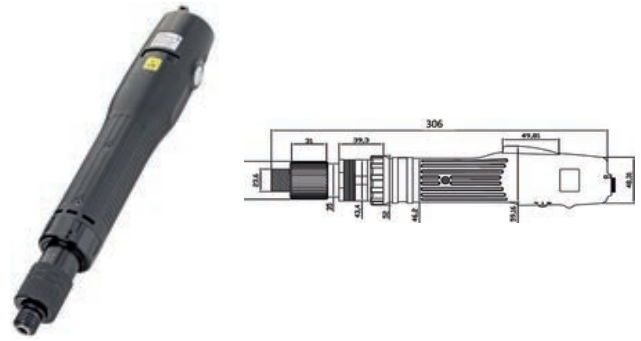

Low-voltage screwdrivers of the BK 900 series achieve higher speeds along with lower heating. Screw counting function and soft start are optionally possible with soft start module. Suitable for cleanroom workplaces, as no carbon dust is ejected.

Technical data screwdriver:

Length:	306 mm
Weight:	1030 g
Voltage / power:	40 VDC / 260 W
Accuracy:	±5 %
Bit type:	B type 6.35 mm
Power supply unit/Controller:	see accessories

Model	SKD-BK960L	SKD-BK960P	SKD-BK990L
Start type	lever start	push start	lever start
Torque	2-6 Nm	2-6 Nm	3-9 Nm
Idle speed	700-1000	700-1000	750-1000
Screw size thread screw	2.6-4.0	2.6-4.0	2.6-4.0
Screw size self-tapping	2.6-3.5	2.6-3.5	2.6-3.5
Power supply unit/Controller	SKP-40B-HL-800, SKP-BC40HL-800 V3.0/3.1		

Model	SKD-BK990P	SKD-BK9120L	SKD-BK9120P
Start type	push start	lever start	push start
Torque	3-9 Nm	6-12 Nm	6-12 Nm
Idle speed	750-1000	660-880	660-880
Screw size thread screw	2.6-4.0	4.0-5.0	4.0-5.0
Screw size self-tapping	2.6-3.5	<4	<4
Power supply unit/Controller	SKP-40B-HL-800, SKP-BC40HL-800 V3.0/3.1		

dpvlink 22903

Article	Type	
SKD-BK960L-ESD	SKD-BK960L-ESD electric screwdriver lever start, 40V, without control unit	
SKD-BK960P-ESD	SKD-BK960P-ESD electric screwdriver push start, 40V, without control unit	
SKD-BK990L-ESD	SKD-BK990L-ESD electric screwdriver Lever start 40V, without control unit	
SKD-BK990P-ESD	SKD-BK990P-ESD electric screwdriver Push start, 40V, without screwdriver	
SKD-BK9120L-ESD	SKD-BK9120L-ESD electric screwdriver Lever start, 40V, without control unit	
SKD-BK9120P-ESD	SKD-BK9120P-ESD electric screwdriver Lever start, 40V, without control unit	

Electric screwdrivers BE 200 series

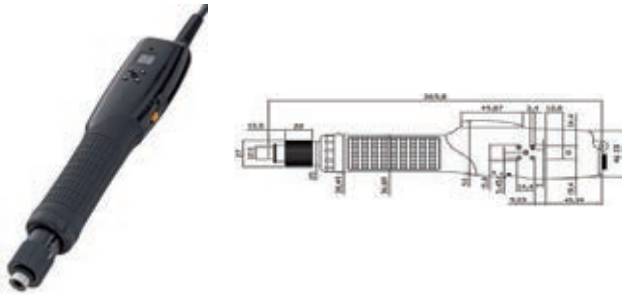

All settings of the **low-voltage screwdrivers of the BE 200 series** like quantity of screws, minimum and maximum time are adjusted at the screwdriver. The min/max values of the fastening time are measured by means of the auto-learn function and automatically stored in the screwdriver.

Technical data screwdriver:

Length:	240 mm
Weight:	330 g
Voltage / power:	32 VDC / 25 W
Accuracy:	±3 %
Bit type:	B type 6.35 mm
Power supply unit/Controller:	see accessories

- Integrated screw counting function (with inverse counting) and fastening time control (1 - 99 screws, 0.01 - 9.9 seconds)
- Automatic left-hand rotation after torque shut-off adjustable

Model	SKD-BE203L	SKD-BE207L	SKD-BE210L	SKD-BE210P
Start type	lever start	lever start	lever start	push start
Torque	0.02-0.34 Nm	0.05-0.69 Nm	0.10-0.98 Nm	0.10-0.98 Nm
Idle speed High	1000	1000	1000	1000
Idle speed Low	700	700	700	700
Screw size thread screw	1.0-2.3	1.4-2.6	1.6-3.0	1.6-3.0
Screw size self-tapping	1.0-2.0	1.4-2.3	1.6-2.6	1.6-2.6
Power supply unit/ Controller	SKP-32BC-60W			

dpvlink 20216

Article	Type
SKD-BE203L-ESD	SKD-BE203L-ESD electric screwdriver lever start, 32V, without control unit
SKD-BE207L-ESD	SKD-BE-207L-ESD electric screwdriver lever start, 32V, without control unit
SKD-BE210L-ESD	SKD-BE-210L-ESD electric screwdriver lever start, 32V, without control unit
SKD-BE210P-ESD	SKD-BE-210P-ESD electric screwdriver push start, 32V, without control unit



Electric screwdrivers BE 500 series

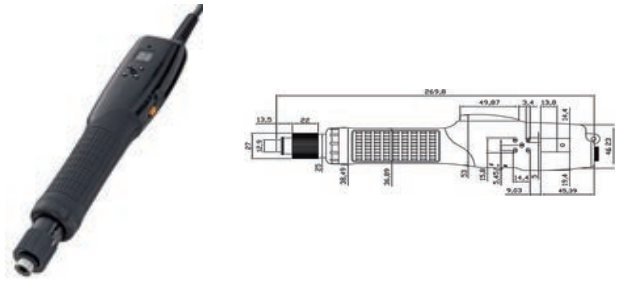

All settings of the **low-voltage screwdrivers of the BE 500 series** like quantity of screws, minimum and maximum time are adjusted at the screwdriver. The min/max values of the fastening time are measured by means of the auto-learn function and automatically stored in the screwdriver.

Technical data screwdriver:

Length:	270 mm
Weight:	580 g
Voltage / power:	32 VDC / 55 W
Accuracy:	±3 %
Bit type:	B type 6.35 mm
Power supply unit/Controller:	see accessories

- Integrated screw counting function (with inverse counting) and fastening time control (1 - 99 screws, 0.01 - 9.9 seconds)
- Automatic left-hand rotation after torque shut-off adjustable

Model	SKD-BE512P	SKD-BE519P
Start type	push start	push start
Torque	0.2-1.2 Nm	0.3-1.86 Nm
Idle speed High	1000	1000
Idle speed Low	650	650
Screw size thread screw	1.6-3.0	2.3-3.5
Screw size self-tapping	1.6-2.6	2.3-3.0
Power supply unit/ Controller	SKP-32BC-60W	

dpvlink 20265

Article	Type
SKD-BE512P-ESD	SKD-BE512P-ESD electric screwdriver push start, 32V, without control unit
SKD-BE519P-ESD	SKD-BE519P-ESD electric screwdriver push start, 32V, without control unit



Electric screwdrivers

Electric screwdrivers BE 800 series

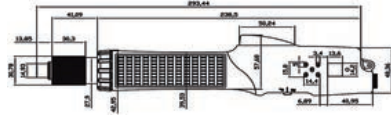

All settings of the **low-voltage screwdrivers of the BE 800 series** like quantity of screws, minimum and maximum time are adjusted at the screwdriver. The min/max values of the fastening time are measured by means of the auto-learn function and automatically stored in the screwdriver.

Technical data screwdriver:

Length:	294 mm
Weight:	820 g
Voltage / power:	40 VDC / 90 W
Accuracy:	±3 %
Bit type:	B type 6.35 mm
Power supply unit/Controller:	see accessories

- Integrated screw counting function (with inverse counting) and fastening time control (1 - 99 screws, 0.01 - 9.9 seconds)

Model	SKD-BE850L
Start type	lever start
Torque	1.96-4.90 Nm
Idle speed	700-1000
High	
Screw size thread screw	4.5-5.0
Screw size self-tapping	< 4
Power supply unit/Controller	SKP-40B-HLN

dpmlink 20284

Article	Type
SKD-BE850L-ESD	SKD-BE850L-ESD electric screwdriver lever start, 40V, without control unit



Electric screwdrivers RBK series

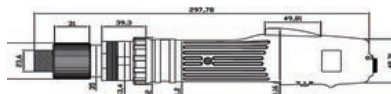

Low-voltage screwdrivers of the RBK series achieve higher speeds along with lower heating. Screw counting function and soft start are optionally possible with soft start module. Suitable for cleanroom workplaces, as no carbon dust is ejected.

Technical data screwdriver:

Length:	298 mm
Voltage:	40 VDC
Accuracy:	±5 %
Bit type:	B type 6.35 mm
Power supply unit/Controller:	see accessories

Model	SKD-RBK60L	SKD-RBK60P	SKD-RBK90L	SKD-RBK90P
Start type	lever start	push start	lever	push start
Power	100W	100W	120W	120W
Torque	2-6 Nm	2-6 Nm	3-9 Nm	3-9 Nm
Idle speed	700-1000	700-1000	550-800	550-800
Screw size thread screw	4.0-5.0	4.0-5.0	5.0-6.0	5.0-6.0
Screw size self-tapping	<4	<4	<4.5	<4.5
Weight	1250 g			
Power supply unit/Controller	SKP-40BC-HL-800			

Model	SKD-RBK120L	SKD-RBK120P	SKD-RBK180L	SKD-RBK180P
Start type	lever start	push start	lever start	push start
Power	120W	120W	200W	200W
Torque	4-12 Nm	4-12 Nm	6-18 Nm	6-18 Nm
Idle speed	380-550	380-550	240-350	240-350
Screw size thread screw	<8	<8	<10	<10
Screw size self-tapping	<6	<6	<8	<8
Weight	1250 g			
Power supply unit/Controller	SKP-40BC-HL-800			

Model	SKD-RBK250L	SKD-RBK250P	SKD-RBK350L	SKD-RBK350P
Start type	lever start	push start	lever start	push start
Power	260W	260W	260W	260W
Torque	8-25 Nm	8-25 Nm	12-35 Nm	12-35 Nm
Idle speed	240-350	240-350	240-350	240-350
Screw size thread screws	<8	<8	<10	<10
Screw size self-tapping	<6	<6	<8	<8
Weight	1450 g		2200 g	
Power supply unit/Controller	SKP-40BC-HL-800			

dpmlink 20371

Article	Type
---------	------

SKD-RBK60L-ESD **SKD-RBK60L-ESD electric screwdriver**
without control unit

SKD-RBK60P-ESD **SKD-RBK60P-ESD electric screwdriver**
lever start, 40V, without control unit

SKD-RBK90L-ESD **SKD-RBK90L-ESD electric screwdriver**
without control unit

SKD-RBK90P-ESD **SKD-RBK90P-ESD electric screwdriver**
lever start, 40V, without control unit

SKD-RBK120L-ESD **SKD-RBK120L-ESD electric screwdriver**
lever start, 40V, without control unit

SKD-RBK120P-ESD **SKD-RBK120P-ESD electric screwdriver**
push start, 40V, without control unit

SKD-RBK180L-ESD **SKD-RBK180L-ESD electric screwdriver**
lever start, 40V, without control unit

SKD-RBK180P-ESD **SKD-RBK180P-ESD electric screwdriver**
push start, 40V, without control unit

SKD-RBK250L-ESD **SKD-RBK250L-ESD electric screwdriver**
without control unit

SKD-RBK250P-ESD **SKD-RBK250P-ESD electric screwdriver**
push start, 40V, without control unit

SKD-RBK350L-ESD **SKD-RBK350L-ESD electric screwdriver**
lever start, 40V, without control unit

SKD-RBK350P-ESD **SKD-RBK350P-ESD electric screwdriver**
without control unit



Electric screwdrivers BNK series

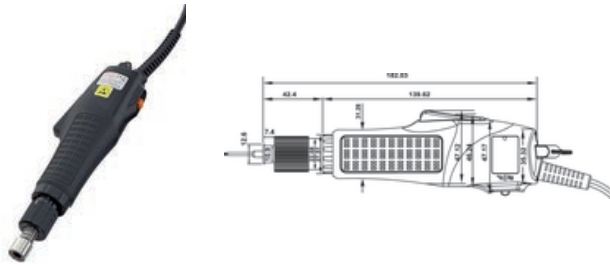

Low-voltage screwdrivers of the BNK series achieve higher speeds along with lower heating.

Technical data screwdriver:

Length:	182 mm
Voltage:	32 VDC
Accuracy:	±5 %
Bit type:	B type 6.35 mm

[dpvlink 22478](#)



Article	Type
SKD-BNK203L-ESD	SKD-BNK203L-ESD Electric screwdriver lever start, 32V, without control unit
SKD-BNK207L-ESD	SKD-BNK207L-ESD Electric screwdriver lever start, 32V, without control unit
SKD-BNK210L-ESD	SKD-BNK210L-ESD Electric screwdriver lever start, 32V, without control unit
SKD-BNK512L-ESD	SKD-BNK512L-ESD Electric screwdriver lever start, 32V, without control unit
SKD-BNK512LF-ESD	SKD-BNK512LF-ESD Electric screwdriver lever start, high-speed, 32V, without control unit
SKD-BNK512P-ESD	SKD-BNK512P-ESD Electric screwdriver push start, 32V, without control unit
SKD-BNK512PF-ESD	SKD-BNK512PF-ESD Electric screwdriver push start, high-speed, 32V, without control unit
SKD-BNK517LF-ESD	SKD-BNK517LF-ESD Electric screwdriver lever start, high-speed, 32V, without control unit
SKD-BNK517PF-ESD	SKD-BNK517PF-ESD Electric screwdriver push start, high-speed, 32V, without control unit
SKD-BNK519L-ESD	SKD-BNK519L-ESD Electric screwdriver lever start, 32V, without control unit
SKD-BNK519P-ESD	SKD-BNK519P-ESD Electric screwdriver push start, 32V, without control unit
SKD-BNK830L-ESD	SKD-BNK830L-ESD Electric screwdriver lever start, 32V, without control unit
SKD-BNK830P-ESD	SKD-BNK830P-ESD Electric screwdriver push start, 32V, without control unit
SKD-BNK850L-ESD	SKD-BNK850L-ESD Electric screwdriver lever start, 32V, without control unit
SKD-BNK850P-ESD	SKD-BNK850P-ESD Electric screwdriver push start, 32V, without control unit
SKD-BNK9120L-ESD	SKD-BNK9120L-ESD Electric screwdriver lever start, 32V, without control unit

Electric screwdriver CG series

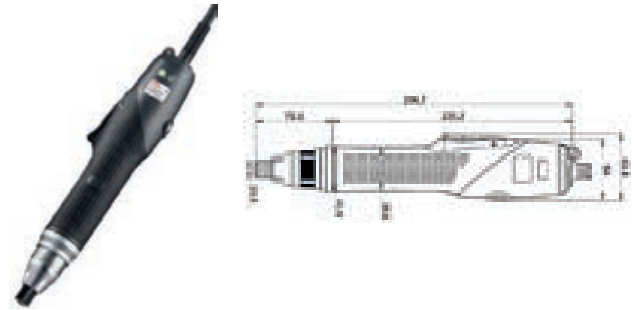

Intelligent screw system with torque and angle monitoring, screw counting and process monitoring and integrated screw hole lighting with white LEDs. Torque steplessly adjustable.

Technical data screwdriver:

Length:	297 mm
Weight:	830 g
Voltage / power:	40 VDC / 90 W
Bit type:	B type 6.35 mm

Model	SKT-CG30	SKT-CG50	SKT-CG70
Start type	lever / push start	lever / push start	lever / push start
Torque	0.3-3.0 Nm	0.5-5.0 Nm	0.8-7.0 Nm
Speed max.	1600	1100	660
Supply unit/controller	SKT-KL-TCG		

[dpvlink 24714](#)



Article	Type
SKT-CG30-ESD	SKT-CG30-ESD EC Electric screwdriver CG series lever and push start, without control unit
SKT-CG50-ESD	SKT-CG50-ESD EC Electric screwdriver CG series lever and push start, without control unit
SKT-CG70-ESD	SKT-CG70-ESD EC Electric screwdriver CG series lever and push start, without control unit

Straight cordless screwdriver SKC-PTA-BS series



ESD industrial quality with high repeat accuracy and included battery monitoring, can be compared to corded electric screwdrivers. The brushless motor technology is durable and maintenance-free.

Technical data of the screwdriver SKC-PTA-BS12/12S1:

Length: 225 mm (without battery)
Diameter: 60 mm (without battery)
Voltage / power: 7.2 VDC / 25 W
Bit type: B type 6.35 mm

Length: 225 mm (without battery)
 Diameter: 60 mm (without battery)
 Voltage / power: 7.2 VDC / 25 W
 Bit type: B type 6.35 mm

Technical data of the screwdriver SKC-PTA-BS20/30/40:

Length: 270 mm (without battery)
Diameter: 60 mm (without battery)
Voltage / power: 10.8 VDC / 25 W
Bit type: B type 6.35 mm

Technical data of the screwdriver SKC-PTA-BS20/30/45P:

Length: 300 mm (without battery)
Diameter: 60 mm (without battery)
Voltage / power: 10.8 VDC / 25 W
Bit type: B type 6.35 mm

Model	SKC-PTA-BS12-ESD	SKC-PTA-BS12S1-ESD
Torque	0.2-1.2 Nm	0.2-1.2 Nm
Idle speed High	1000	500
Idle speed Low	700	350
Charger	SKC-P25W	
Weight	0.53 kg without battery	
Battery	SKC-LB0725S	

Model	SKC-PTA-BS20-ESD	SKC-PTA-BS30-ESD	SKC-PTA-BS45-ESD
Torque	0.3-2.0 Nm	0.8-3.0 Nm	1.5-4.5 Nm
Idle speed High	1200	1200	700
Idle speed Low	850	850	500
Charger	SKC-P50W-S		
Batteries	SKC-LB1025S		

Model	SKC-PTA-BS20P-ESD	SKC-PTA-BS30P-ESD	SKC-PTA-BS45P-ESD
Torque	0,5-2,0 Nm	1,0-3,0 Nm	2,0-4,5 Nm
Idle speed High	1200	1200	700
Idle speed Low	-	-	-
Charger	SKC-P50WN-S		
Weight	0.7 kg without battery		
Battery	SKC-LB1025S		

dpvlink 22983



Article Type
 SKC-PTA-BS12-ESD **SKC-PTA-BS12-ESD Straight cordless screwdriver**
 incl. 1 battery SKC-LB1025S
 stepless torque setting
 charger not included in the scope of delivery

SKC-PTA-BS12S1-ESD **SKC-PTA-BS12S1-ESD Straight cordless screwdriver**
 incl. 1 battery SKC-LB1025S
 stepless torque setting
 charger not included in the scope of delivery

SKC-PTA-BS20-ESD **SKC-PTA-BS20-ESD Straight cordless screwdriver**
 incl. 1 battery SKC-LB1025S
 stepless torque setting
 charger not included in the scope of delivery

dpvlink 22983



Article Type
 SKC-PTA-BS30-ESD **SKC-PTA-BS30-ESD Straight cordless screwdriver**
 incl. 1 battery SKC-LB1025S
 stepless torque setting
 charger not included in the scope of delivery

SKC-PTA-BS45-ESD **SKC-PTA-BS45-ESD Straight cordless screwdriver**
 incl. 1 battery SKC-LB1025S
 stepless torque setting
 charger not included in the scope of delivery

SKC-PTA-BS20P-ESD **SKC-PTA-BS20P-ESD Straight cordless screwdriver**
 incl. 1 battery SKC-LB1025S
 stepless torque setting
 charger not included in the scope of delivery

SKC-PTA-BS30P-ESD **SKC-PTA-BS30P-ESD Straight cordless screwdriver**
 incl. 1 battery SKC-LB1025S
 stepless torque setting
 charger not included in the scope of delivery

SKC-PTA-BS45P-ESD **SKC-PTA-BS45P-ESD Straight cordless screwdriver**
 incl. 1 battery SKC-LB1025S
 stepless torque setting
 charger not included in the scope of delivery

Accessories for cordless screwdriver SKC-PTA-BS series



dpvlink 22987



Article Type
 SKC-LB1030S **Replacement battery for SKC-PTA-BS/BT20/30/45**
 SKC-P25W **Charger for PTA-BS12/12S1**
 SKC-P50W-S **Charger for SKC-PTA-BS20/30/45**

Cordless screwdriver series SKC-PTA-BT



ESD industrial quality with high repeat accuracy and included battery monitoring, can be compared to corded electric screwdrivers. The brushless motor technology is durable and maintenance-free.

Technical data of the screwdriver SKC-PTA-BT20FB/30B/45B:

Length: 225 mm (without battery)
Diameter: 60 mm (without battery)
Voltage: 10.8 V DC
Bit type: B type 6.35 mm

dpvlink 26384



Article Type
 SKC-PTA-BT20FB-ESD **SKC-PTA-BT20FB-ESD Straight cordless screwdriver**
 incl. 1 battery SKC-LB1025S
 stepless torque setting
 charger not included in the scope of delivery

SKC-PTA-BT30B-ESD **SKC-PTA-BT30B-ESD Straight cordless screwdriver**
 incl. 1 battery SKC-LB1025S
 stepless torque setting
 charger not included in the scope of delivery

SKC-PTA-BT45B-ESD **SKC-PTA-BT45B-ESD Straight cordless screwdriver**
 incl. 1 battery SKC-LB1025S
 stepless torque setting
 charger not included in the scope of delivery

Control units Kilews

Power supply units for brushless low-voltage screwdrivers



Using the Kilews control units helps you to achieve absolutely faultless screwings. Improve the product quality and process reliability and support thus your quality management.

dpvlink 20329



Article	Type
 SKP-32BC-60W	Power supply unit for SKD-BN200 / BN500 100-240V AC, output 40V DC, 213 x 131 x 65 mm, 0.25 kg
 SKP-BC40HL-800.V4.0	Power supply unit for SKD-RBK / TBK / BK900 with counting and writing function 100-240V AC, reverse output 24V / 32V / 40V DC, 213 x 131 x 65 mm, 1.8 kg
 SKP-BC40HL-800.V4.1	Power supply unit for SKD-RBK / TBK / BK900 with counting and writing function inputs: sensor/release, reset, start, external program selection 100-240V AC, output 24V / 32V / 40V DC, 213 x 131 x 65 mm, 1.8 kg
 SKP-BC40HLN-V4.0	Power supply unit for SKD-BN200 / BN500 / BN800 with counting and writing function inputs: sensor/release, reset, start, reverse 100-240V AC, output 24V / 32V / 40V DC, 213 x 131 x 65 mm, 1.8 kg
 SKP-BC40HLN-V4.1	Power supply unit for SKD-BN200 / BN500 / BN800 with counting and writing function inputs: sensor/release, reset, start, external program selection 100-240V AC, output 24V / 32V / 40V DC, 213 x 131 x 65 mm, 1.8 kg
 SKP-40B-HL-800	Power supply unit for SKD-BK900 / RBK 100-240V AC, output 24V / 32V / 40V DC, 213 x 131 x 65 mm, 1.8 kg
 SKP-40B-HLN	Power supply unit for SKD-BN800 / BE800 100-240V AC, output 40V DC, 213 x 131 x 65 mm, 1.8 kg
 SKP-BE32HLN	Power supply unit for SKD-BN500LF / BN500PF / BN700 100-240V AC, output LO 24V / HI 32V DC, 200 x 80 x 66 mm, 0.46 kg
 SKP-12HL	Power supply unit for SKD-B 100 100-240V AC, output voltage: 9V DC / 12V DC, 100 x 50 x 35 mm, weight 0.15 kg

Control unit KL-MCTDS5



KL-MCTDS5 Control unit with fastening time monitoring and counting function for 5 screwdrivers.



- torque display for electric screwdrivers with torque clutch
- up to 5 screwdrivers with one control unit
- counting function, fastening time monitoring and output signals
- torque display for every screwdriver
- data output of the measured data on PC or server

Model	KL-MCTDS5
Input voltage	DC 32/40 V
Output voltage	DC 40V/32V/24V 5.5A/6.9A/9.2A
Counting range	1-99 screws
Soft start time	0-9.9 s
Soft start speed	30% - 85% of the maximal speed
Inputs	Sensor, release, reverse, confirm
Outputs	IO, NIO, sum IO, Stop
Serial interface	2 x RS232

dpvlink 23967



Article Type
KL-MCTDS5 **Control unit for SMART Tools 5-fold**
can be used with all screwdrivers of the series SKD-BNK

Controller for SKT-CG series

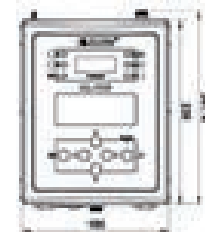

Technical data:

Dimensions:	185 x 214 x 147 mm
Weight:	3.7 kg
Input voltage:	100 - 200 V AC
Output voltage:	24 V DC / 25 W
Inputs:	Start / Forward / Reverse / Disable / Confirm
Outputs:	OK / NG / OK ALL / Start / Reverse
Serial interface:	RS-232X2, Micro SD, LAN

dpvlink 24720



Article Type
SKT-KL-TCG **Controller for SKT-CG series**
100-240V AC, output 24V DC, 185 x 214 x 147 mm, 3.7 kg

Accessories Kilews

Soft start module KL-SSBN



Soft start module for brushless screwdrivers is suitable for SKD-BN200, SKD-BN500, SKD-BN800, SKD-RBK/TBN. Soft start is automatically disabled in the left-hand rotation.

- adjustable from 0.1 - 9.9 secondes
- Speed adjustable 30% - 100%
- Output signals for right-hand rotation, left-hand rotation, shut-off 24V DC, 200mA
- Optionally with separately adjustable soft start for right-hand and left-hand rotation

dpwlink 26700

Article	Type
SKZ-KL-SSBN	Soft start module KL-SSBN

Torque display KL-CTDS

In combination with a Kilews SKD-BNK or SKD-RBK screwdriver the torque reached by the coupling is measured and displayed.



- process monitoring and data archiving possible
- E/A interface for controlling the screwdriver and connection to superordinated controls
- soft start function
- fastening time monitoring and screw counting function

Model	KL-CTDS
Input voltage	DC 32/40 V
Output voltage	DC 40V/32V/24V 5.5A/6.9A/9.2A
Counting range	1-99 screws
Soft start time	0-9.9 s
Soft start speed	30% - 85% of the maximal speed
Inputs	Sensor, release, reverse, confirm
Outputs	IO, NIO, sum IO, Stop
Serial interface	2 x RS232

dpwlink 23965

Article	Type
KL-CTDS	KL-CTDS Torque display module can be used with all screwdrivers of the series SKD-BNK 200 / 500 / 800 / 900 / RBNK / TBNK

Angular head KL 90°



Angular heads 90° for screwdrivers with lever start by Kilews, 1/4" hexagon

dpwlink 20617

Article	Type
SKZ-KL-1	Angle head KL-1 90° only for screwdrivers with lever start suitable for SKD-BN800, SKD-7000, SKD-8000, SK-82 and SK-92 series
SKZ-KL-2	Angle head KL-2 90° only suitable for screwdrivers with lever start, suitable for SKD BE 500
SKZ-KL-3B	Angle head KL-3b 90° only suitable for screwdrivers with lever start, suitable for SKD RBK

Pistol handle ESD



Pistol handles for lever and push start models

- easy to attach
- can be retrofitted at any time

dpwlink 25213

Article	Type
SKZ-LG-11S	Pistol handle for series SKD BE 500 ESD lever start only for lever start screwdrivers series SKD-BE500 ESD
SKZ-PG-11S	Pistol handle for series SKD BE 500 ESD push start only for push start screwdrivers series SKD-BE500 ESD
SKZ-LG-10S	Pistol handle for series SKD BN 500 ESD lever start only for lever start screwdrivers series SKD-BN500 ESD
SKZ-LG-12S	Pistol handle for series SKD BE 800 ESD lever start only for lever start screwdrivers series SKD-BE800 ESD
SKZ-PG-12S	Pistol handle for series SKD BE 800 ESD push start only for push start screwdrivers series SKD-BE800 ESD
SKZ-LG-8S	Pistol handle for series SKD BN 800 ESD lever start only for lever start screwdrivers series SKD-BN800 ESD
SKZ-PG-8S	Pistol handle for series SKD BN 800 ESD push start only for push start screwdrivers series SKD-BN800 ESD
SKZ-LG-13S	Pistol handle for series SKD-BK900 ESD lever start only for lever start screwdrivers series SKD-BK900 ESD
SKZ-LG-15S	Pistol handle for series SKT CG ESD only for screwdrivers series SKT-CG ESD

ESD torque sleeve



ESD torque sleeve as adjustment protection for the torque of Kilews screwdrivers

dpwlink 20615

Article	Type
SKZ-KC-2S	Torque sleeve ESD KC-2S ESD plastic black suitable for SKD BN 700 and BE 700 series
SKZ-KC-6S	Torque sleeve ESD KC-6S ESD plastic black suitable for SKD BN 500 and BE 500
SKZ-KC-7S	Torque sleeve ESD KC-7S ESD plastic black suitable for SKD BN 800 and BE 800 series
SKZ-KC-9S	Torque sleeve ESD KC-9S ESD plastic black suitable for SKD B 100 series
SKZ-KC-22A	Torque sleeve ESD KC-22A ESD plastic black suitable for SKD RBK series
SKZ-A29096	Aluminium torque sleeve A29096 suitable for series SKD BN 500 and BE 500
SKZ-A29097	Aluminium torque sleeve A29097 suitable for series BN 800 and BE 800

ESD torque adjustment aid



ESD-compliant torque adjustment aid made of stainless steel. Available for Kilews screwdrivers of BN and BE series

dpwlink 20614

Article	Type
SKZ-KW-1	Torque adjustment aid ESD for SKD BN 700 / BE 700 and BN 800 / BE 800 series
SKZ-KW-3	Torque adjustment aid ESD for SKD BN 500 / BE 500 series
SKZ-KW-4	Torque adjustment aid ESD for SKD BN 200 / BE 200 series

Tool holder



Tool holder for manually operated electric screwdrivers. Available as holder with or without pivoting device.

dpvlink 20616



Article	Type
SKZ-KH-2	Tool holder KH-2 suitable for low-voltage screwdrivers series SKD BN 800 and BE 800
SKZ-KH-4	Tool holder KH-4 suitable for low-voltage screwdrivers series SKD BN 500 and BE 500
SKZ-KH-5	Tool holder KH-5 suitable for low-voltage screwdrivers series SKD BN 200 and BE 200
SKZ-KH-6	Tool holder KH-6 with pivoting holder and plastic insert suitable for low-voltage screwdrivers series SKD BN 800 and BK 900
SKZ-KH-7	Tool holder KH-7 with pivoting holder and plastic insert suitable for low-voltage screwdrivers series RBK

Electric screwdrivers Delvo



Delvo Electric screwdriver DLV7321 / DLV7331 BKE

Torque range 0.05 - 1.18 nm

Lever Starter
DLV 7321
DLV 7331



The control of the electric screwdriver takes place via a separate control unit with speed preselection and soft start regulation.

The DLV 7321 starts progressively, i.e. the rotation starts slowly and speeds up automatically. Thus, damages of sensitive screw heads are largely avoided.

Technical data screwdriver:

Length / handle:	215 mm / 32 mm
Weight:	350 g
Voltage / output:	36 VDC / 26 W
Speed:	
DLV 7321	steplessly 700-1000 rpm
DLV 7331	steplessly 500-700 rpm
Torque setting range:	
DLV 7321	steplessly 0.05 - 0.49 nm
DLV 7331	steplessly 0.29 - 1.18 nm
Repeat accuracy:	3 %
Tool holder:	1/4" hexagon

Technical data control unit DLC-1213:

Input / output voltage:	220 / 240 VAC, 50-60 Hz / 24 VDC
Dimensions:	143 x 145 x 105 mm
Weight:	1.7 kg

dpvlink 3431



Article	Type
461.300	DLV-7321-BKE electric screwdriver ESD with lever start, without control unit
461.310	DLV-7331-BKE electric screwdriver ESD With lever start, without control unit

Electric screwdrivers

Delvo Electric screwdriver DLV 75.. / 85..

Torque range 0,49 - 4.41 nm



Lever Starter
DLV 7530
DLV 7540
DLV 7550

Push Starter
DLV 8530
DLV 8540
DLV 8550

The electric screwdrivers DLV 7530/40/50 with lever start and DLV 8530/40/50 with push start have been designed to solve specific screwing problems. All operating and functional units are integrated into the handpiece. The screwdrivers offer all preconditions for serial production work in assembly.

Technical data:

Length / handle:	257 mm / 39.5 mm
Weight:	650 g
Voltage / output:	34 VDC / 36 W
Speed:	DLV 7530 / 8530 1200 rpm DLV 7540 / 8540 800 rpm DLV 7550 / 8550 500 rpm.

Torque setting range:

DLV 7530 / 8530	steplessly 0.49 - 1.67 nm
DLV 7540 / 8540	steplessly 1.18 - 2.65 nm
DLV 7550 / 8550	steplessly 1.96 - 4.41 nm
Repeat accuracy:	3 %
Tool holder:	1/4" hexagon

dpvlink 3492

Article	Type
462.400	DLV 8530 electric screwdriver with push start, without control unit
462.400.ESD	DLV 8530 Electric screwdriver ESD with push start, without control unit
462.400.H	DLV 7530 electric screwdriver with lever start, without control unit
462.400.H.ESD	DLV 7530 Electric screwdriver ESD with lever start, without control unit
462.410	DLV 8540 electric screwdriver with push start, without control unit
462.410.ESD	DLV 8540 Electric screwdriver ESD with push start, without control unit
462.410.H	DLV 7540 electric screwdriver with lever start, without control unit
462.410.H.ESD	DLV 7540 Electric screwdriver ESD with lever start, without control unit
462.420	DLV 8550 electric screwdriver with push start, without control unit
462.420.ESD	DLV 8550 Electric screwdriver ESD with push start, without control unit
462.420.H	DLV 7550 electric screwdriver with lever start, without control unit
462.420.H.ESD	DLV 7550 Electric screwdriver ESD with lever start, without control unit

Control units Delvo

dpvlink 25701

Article	Type
461.350	DLC-1213 control unit (230VAC / 24VDC) with soft start and speed preselection for screwdrivers DLV 7321, 7331
462.451	DLC-4511 GGB control unit 230 VAC / 34 V with soft start and speed control for screwdrivers DLV 7530, 7540, 7550, 8530, 8540, 8550

Accessories Delvo

dpvlink 3439

Article	Type
461.620	Torque adjustment protection/cap for DLV 73..
462.620	Torque adjustment protection/cap for DLV-75.../ 85..

Accessories electric screwdrivers

Balancer

Balancer with rope pull-in with steplessly adjustable load capacity. Very durable, excellent balancing performance.

dpvlink 20618

Article	Type
SKZ-RW-3	Spring balancer 1.0 - 3.0 kg Load capacity 1.0 - 3.0 kg rope length 2 m
SKZ-TW-06R	Spring balancer 0.2 - 0.6 kg Load capacity 0.2 - 0.6 kg rope length 1.5 m
SKZ-TW-1R	Spring balancer 0.5 - 1.5 kg Load capacity 0.5 - 1.5 kg rope length 1.5 m

ESD screw tray



ESD vibrating screen / screw tray for different screws

dpvlink 20613

Article	Type
SKZ-KB-1-ESD	ESD screw tray M1.7 - 2.0
SKZ-KB-2-ESD	ESD screw tray M2.0 - 2.8
SKZ-KB-3-ESD	ESD screw tray M3.0 - 4.0

Support arm and torque support

KDA telescopic torque supports



Telescopic torque supports KDA of carbon are very lightweight and flexible. Avoid symptoms of fatigue and injuries by ergonomic working. Screw even high torques in a safe and uncomplicated way.

- Series KDA suitable for straight screwdrivers or screwdrivers with pistol grip
- Series KDAA suitable for screwdrivers with angle head 90°
- tool holder already included
- supports torques / reaction torques perpendicular to its axis
- durable and maintenance-free carbon tubes
- stressless ergonomic working
- mounting of balancers and spring balancers directly on the arm



Series KDA

Technical data:

Article	Torque	Length min	Length max	Tool Ø
KDA15-0600	15 Nm	350 mm	664 mm	23-44 mm
KDA15-1000	15 Nm	510 mm	1120 mm	23-44 mm
KDA15-2000	15 Nm	835 mm	2119 mm	23-44 mm
KDA40-1000	40 Nm	517 mm	1127 mm	32-47 mm
KDA40-1500	40 Nm	684 mm	1628 mm	32-47 mm
KDA40-2000	40 Nm	852 mm	2132 mm	32-47 mm
KDA80-1000	80 Nm	528 mm	1140 mm	32-47 mm
KDA80-1500	80 Nm	695 mm	1641 mm	32-47 mm

KDAA

Technical data:

Article	Torque	Length min	Length max	Tool Ø
KDA-a15-0600	15 Nm	414 mm	665 mm	23-44 mm
KDA-a15-1000	15 Nm	503 mm	1123 mm	23-44 mm
KDA-a15-1500	15 Nm	668 mm	1618 mm	23-44 mm
KDA-a15-2000	15 Nm	835 mm	2119 mm	23-44 mm
KDA-a40-1000	40 Nm	505 mm	1120 mm	32-47 mm
KDA-a40-1500	40 Nm	684 mm	1628 mm	32-47 mm
KDA-a40-2000	40 Nm	862 mm	2142 mm	32-47 mm
KDA-a80-1000	80 Nm	528 mm	1140 mm	32-47 mm
KDA-a80-1500	80 Nm	695 mm	1641 mm	32-47 mm

dpvlink 20466

Article	Type
KDA15-0600	Carbon torque support 15 Nm Length min 350 mm, length max 664 mm Suitable for straight screwdrivers or screwdrivers with pistol grip
KDA15-1000	Carbon torque support 15 Nm Length min 510 mm, length max 1120 mm Suitable for straight screwdrivers or screwdrivers with pistol grip
KDA15-1500	Carbon torque support 15 Nm Length min 665 mm, length max 1610 mm Suitable for straight screwdrivers or screwdrivers with pistol grip



dpvlink 20466



Article	Type
KDA15-2000	Carbon torque support 15 Nm Length min 835 mm, length max 2119 mm Suitable for straight screwdrivers or screwdrivers with pistol grip
KDA40-1000	Carbon torque support 40 Nm Length min 517 mm, length max 1127 mm Suitable for straight screwdrivers or screwdrivers with pistol grip
KDA40-1500	Carbon torque support 40 Nm Length min 684 mm, length max 1628 mm Suitable for straight screwdrivers or screwdrivers with pistol grip
KDA40-2000	Carbon torque support 40 Nm Length min 852 mm, length max 2132 mm Suitable for straight screwdrivers or screwdrivers with pistol grip
KDA80-1000	Carbon torque support 80 Nm Length min 528 mm, length max 1140 mm Suitable for straight screwdrivers or screwdrivers with pistol grip
KDA80-1500	Carbon torque support 80 Nm Length min 695 mm, length max 1641 mm Suitable for straight screwdrivers or screwdrivers with pistol grip
KDA-a15-0600	Carbon torque support 15 Nm Length min 414 mm, length max 665 mm Suitable for screwdrivers with angle head 90°
KDA-a15-1000	Carbon torque support 15 Nm Length min 503 mm, length max 1123 mm Suitable for screwdrivers with angle head 90°
KDA-a15-1500	Carbon torque support 15 Nm Length min 668 mm, length max 1618 mm Suitable for screwdrivers with angle head 90°
KDA-a15-2000	Carbon torque support 15 Nm Length min 835 mm, length max 2119 mm Suitable for screwdrivers with angle head 90°
KDA-a40-1000	Carbon torque support 40 Nm Length min 505 mm, length max 1120 mm Suitable for screwdrivers with angle head 90°
KDA-a40-1500	Carbon torque support 40 Nm Length min 684 mm, length max 1628 mm Suitable for screwdrivers with angle head 90°
KDA-a40-2000	Carbon torque support 40 Nm Length min 862 mm, length max 2142 mm Suitable for screwdrivers with angle head 90°
KDA-a80-1000	Carbon torque support 80 Nm Length min 528 mm, length max 1140 mm Suitable for screwdrivers with angle head 90°
KDA-a80-1500	Carbon torque support 80 Nm Length min 695 mm, length max 1641 mm Suitable for screwdrivers with angle head 90°

Pivoting support arm ST-1200

Pivoting support arm for mounting torque supports or other tools. The column length is individually adjustable. A two-point fixation on the column provides more safety.

Technical data:

Profile:	Aluminum
Height:	1200 mm
Arm:	600 / 800 / 1200 mm
Pedestal:	135 x 45 mm
Pivoting range:	180°
Load capacity:	max. 6 kg

Optionally available:

- up to 4 pivoting arms on one column
- suitable steel table clamps with fixation screws



dpvlink 20450

Article	Type
ST-1200/0600	Pivoting support arm 0600
ST-1200/0800	Pivoting support arm 0800
ST-1200/1000	Pivoting support arm 1000



Parallel support arm with positioning system

The positioning system PoSy80 assures a **precise tool guidance** when screwing your components. Using the PoSy80 together with the parallel support arm it is possible to determine **every position** on the X, Y and possibly Z-axis. Within the pivoting range this position is **accurate up to 0,01 mm**. The sequence is thereby **free or programmable**.





- analysis of the depth of the screwing (e.g. missing washer)
- specifies position, order and program sequence
- up to 80 positions storable
- suitable for electric, EC and pneumatic screwdrivers



Technical data encoder PoSy3D-Box:

Screwdriver	every screwdriver with corresponding control signals
Program selection	8 programs selectable via Com interface
Interfaces	SPS control signal for controlling the screwdriver Com interface for selecting a program X / Y / Z encoders
LCD-Display	4-lines (2 lines for program, 1 for error and 1 for menu selection)
Power supply	230 V AC, 50 Hz
Dimensions (L x W x H)	150 x 200 x 200 x 110 mm
Weight	2.3 kg

dpvlink 20459

Article	Type
 PoSy3D-Box	Positioning control electronics for parallel support arm PoSy80
 PoSy80-3D	PoSy80 with XYZ encoder for 80 Nm with X, Y encoder and cable 600 mm column with small base plate and mounting plate
 PoSy-80S	PoSy80 base frame with column Span width 850 mm, tool holder max. 45 mm with tool holder, cylinder and pressure controller max. torque 80 Nm
 PoSy-80W	PoSy80 base frame for wall mounting Span width 850 mm, tool holder max. 45 mm with tool holder, cylinder and pressure controller max. torque 80 Nm

Torque testers

Torque tester KTM



Torque tester for adjusting or monitoring the required torques

- USB port for data archiving on PC and printer
- Auto-Reset function
- Measuring direction left and right-hand
- Measuring units Lbf in - kgf cm - Nm
- Measuring mode: peak value, real-time display
- including case and calibration certificat

Technical data:

Accuracy:	± 1%
Power supply:	1.2 V battery
Charging time:	8 hours
Battery operation:	30 hours

dpvlink 20391



Article	Type
SKZ-KTM-15	KTM-15 torque tester up to 1.5 Nm 0.1 - 1.5 Nm 123x230x65 mm; 2 kg
SKZ-KTM-150	KTM-150 torque tester up to 15 Nm 0.15-15.0 Nm 123x230x65 mm; 2 kg
SKZ-KTM-250	KTM-250 torque tester up to 25 Nm 0.3-25.0 Nm 160x200x40 mm; 2 kg

Screw separating units

Screw separating unit Universal KFR-1050



The **first adjustable screw separating unit** switches the unit off automatically when there is no screw in the removal position. The device is adjustable for shaft-heavy screws and screws with captive washer. The feed rail can be easily adjusted to up to 11 sizes. Configure the vibration and feeding speed according to your requirements.



Technical data:

Dimensions (L x W x H)	126 x 182 x 147 mm
Weight	2.2 kg
Voltage	100 - 240 V AC
Power supply unit	15 V DC
Screw sizes	M 1.0 - M 5.0
Screw length	maximal 19 mm thread length
Screw bin	200 - 220 ccm

dpvlink 20455



Article	Ausführung
KFR-1050	Screw separating unit Universal KFR-1050 Shaft M 1.0 to 5.0 mm / length max. 19 mm
KR-45100	Feed rail for KFR-1050 Adjustable feed rail for KFR-1050

Screw separating unit NSB / NSR - Quicher/Othake



The NSB series has a precision feeding system that is suitable for very small screws. With the NSR series, the screw is exempted so that it can be removed e.g. within a screwdriving robot by a screwdriver e.g. with vacuum attachment.

- Electrical connection 240V 50/60Hz (AC adapter included in the scope of delivery), internal DC 15V - 1A
- It also handles screws with washer or spring ring
- Processing speed: 2 screws/sec
- Max. thread length 20 mm
- Vibration intensity is adjustable
- Exchangeable feed rails type NSR
- Adjustable bit guide allows a precise positioning

Type	Screw Ø [mm]	Thread length		Rail type
		Max. [mm]	Filling volume Max. [mm]	
NSB-10 / NSR-10	M 1.0	20	80	SR-10 / SRR-10
NSB-12 / NSR-12	M 1.2	20	80	SR-12 / SRR-12
NSB-14 / NSR-14	M 1.4	20	80	SR-14 / SRR-14
NSB-17 / NSR-17	M 1.7	20	80	SR-17 / SRR-17
NSB-20 / NSR-20	M 2.0	20	80	SR-20 / SRR-20
NSB-23 / NSR-23	M 2.3	20	80	SR-23 / SRR-23
NSB-26 / NSR-26	M 2.6	20	80	SR-26 / SRR-26
NSB-30 / NSR-30	M 3.0	20	80	SR-30 / SRR-30

(*) Guide rails are interchangeable. All types of NSB are available with a screw counter. When ordering, the type number is to be add with a "C".

dpwlink 11293



Article	Ausführung
NSB-10	NSB - Quicher/Othake, shaft up to Ø M 1.0 mm
NSR-10	NSR - Quicher/Othake, shaft up to Ø M 1.0 mm
NSB-12	NSB - Quicher/Othake, shaft up to Ø M 1.2 mm
NSR-12	NSR - Quicher/Othake, shaft up to Ø M 1.2 mm
NSB-14	NSB - Quicher/Othake, shaft up to Ø M 1.4 mm
NSR-14	NSR - Quicher/Othake, shaft up to Ø M 1.4 mm
NSB-17	NSB - Quicher/Othake, shaft up to Ø M 1.7 mm
NSR-17	NSR - Quicher/Othake, shaft up to Ø M 1.7 mm
NSB-20	NSB - Quicher/Othake, shaft up to Ø M 2.0 mm
NSR-20	NSR - Quicher/Othake, shaft up to Ø M 2.0 mm
NSB-23	NSB - Quicher/Othake, shaft up to Ø M 2.3 mm
NSR-23	NSR - Quicher/Othake, shaft up to Ø M 2.3 mm
NSB-26	NSB - Quicher/Othake, shaft up to Ø M 2.6 mm
NSR-26	NSR - Quicher/Othake, shaft up to Ø M 2.6 mm
NSB-30	NSB - Quicher/Othake, shaft up to Ø M 3.0 mm
NSR-30	NSR - Quicher/Othake, shaft up to Ø M 3.0 mm

Pliers

ideal-tek Pliers



ideal-tek pliers stand for quality with the highest requirements of precision, ergonomics and durability.



The cutting shapes and cutting performance:



With bevel (facet)

Normal cut. Suitable for cutting hard and soft steel wires as well as soft materials such as copper wire and cable.



With large bevel (facet)

Suitable for cutting hard and very hard steel wires. Long service life.



Without bevel flush (facet)

Flush cut for soft materials.

ERGO-TEK

The pliers of the ERGO-TEK series have a modified ergonomic handle. This adapts optimally to the hand which has a positive effect on the user especially in case of long, intensive and powerful working processes.

ERGO-TEK SLIM

In consideration of anatomic differences the new, lightweight ERGO-TEK SLIM series has been designed for small hands - providing the same ergonomics, ESD safety and technical advantages that have always characterized ideal-tek

● ERGO-TEK SLIM
● ERGO-TEK



ideal-tek Diagonal cutting pliers ERGO-TEK Slim

The new, lightweight ERGO-TEK SLIM series has been designed for small hands - providing the same ergonomics, ESD safety and technical advantages that have always characterized ideal-tek.

Special features

- Ergonomic handle
- Slip-resistant surface
- Very lightweight
- Suitable for narrow spaces



ESD Diagonal cutting pliers Slim **NEU** 5140/41/42

oval jaws, ERGO-TEK Slim handles ESD dissipative, blue grey, *Swiss-made*



dpvlink 26734



Article	A [mm]	C [mm]	B [mm]	D [mm]	Cu wire [mm]
 I-ES5140.ESD	120	10	10	6.4	0.2 -1.2
 I-ES5141.ESD	120	10	10	6.4	0.1 -1.2
 I-ES5142.ESD	120	10	10	6.4	0.1 -1.0



ESD Diagonal cutting pliers Slim **NEU** 5150/51/52

large, oval jaws, ERGO-TEK Slim handles ESD dissipative, blue grey, *Swiss-made*



dpvlink 26738



Article	A [mm]	C [mm]	B [mm]	D [mm]	Cu wire [mm]
 I-ES5150.ESD	123	12.5	12.5	6.4	0.3 -1.6
 I-ES5151.ESD	123	12.5	12.5	6.4	0.2 -1.6
 I-ES5152.ESD	123	12.5	12.5	6.4	0.2 -1.2



ESD Diagonal cutting pliers Slim **NEU** 5160/61/62

extra large, oval jaws, ERGO-TEK Slim handles ESD dissipative, blue/grey, *Swiss-made*



dpvlink 26743



Article	A [mm]	C [mm]	B [mm]	D [mm]	Cu wire [mm]
 I-ES5160.ESD	127	16	14	6.4	0.5 -3.0
 I-ES5161.ESD	127	16	14	6.4	0.4 -2.5
 I-ES5162L.ESD	127	16	14	6.4	0.4 -2.5



ESD Diagonal cutting pliers Slim **NEU** 5340/41/42

small, pointed jaws, ERGO-TEK Slim handles ESD dissipative, blue grey, *Swiss-made*



dpvlink 26748



Article	A [mm]	C [mm]	B [mm]	D [mm]	Cu wire [mm]
 I-ES5340.ESD	120	10	10	6.4	0.2 -1.2
 I-ES5341.ESD	120	10	10	6.4	0.1 -1.2
 I-ES5342.ESD	120	10	10	6.4	0.1 -1.0



ESD Diagonal cutting pliers Slim **NEU** 5350/51/52

pointed jaws, ERGO-TEK Slim handles ESD dissipative, blue grey, *Swiss-made*



dpvlink 26754



Article	A [mm]	C [mm]	B [mm]	D [mm]	Cu wire [mm]
 I-ES5350.ESD	123	12.5	12.5	6.4	0.3 -1.6
 I-ES5351.ESD	123	12.5	12.5	6.4	0.2 -1.6
 I-ES5352.ESD	123	12.5	12.5	6.4	0.2 -1.2



ESD Diagonal cutting pliers Slim **NEU** 5540/41/42

tapered, small, pointed jaws, ERGO-TEK Slim handles ESD dissipative, blue grey, *Swiss-made*



dpvlink 26758



Article	A [mm]	C [mm]	B [mm]	D [mm]	Cu wire [mm]
 I-ES5540.ESD	120	10	10	6.4	0.2 -1.2
 I-ES5541.ESD	120	10	10	6.4	0.1 -1.2
 I-ES5542.ESD	120	10	10	6.4	0.1 -0.8

ESD Diagonal cutting pliers Slim 5547 NEU

Narrow head angled by 50°, ERGO-TEK Slim handles ESD dissipative, blue grey, without bevel/flush cut, *Swiss-made*

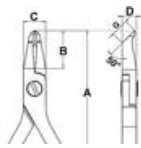

dpvlink 26762

Article	A [mm]	C [mm]	B [mm]	D [mm]	Cu wire [mm]
I-ES5247.ESD	128	10	17	6.4	0.1 -1.2



ESD Diagonal cutting pliers Slim 5250 NEU

Large head angled by 45°, ERGO-TEK Slim handles ESD dissipative, blue/grey, without bevel/flush cut, *Swiss-made*

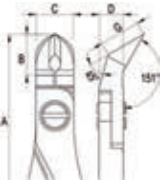

dpvlink 26764

Article	A [mm]	C [mm]	B [mm]	D [mm]	Cu wire [mm]
I-ES5250.ESD	126	10	14.5	6.4	0.2 -1.2



ideal-tek Diagonal cutting pliers ERGO-TEK

The *ideal-tek* ERGO-TEK diagonal cutting pliers series stands for highest requirements for precision and performance. They are made with high quality exclusively in Switzerland. The tools have precision ground, sharp cutting edges for the use e.g. in electronics and fine mechanics. Versions with normal bevel, small bevel or without bevel for precise cuts on sensitive electronic components. A friction-less double spring ensures a smooth and soft opening. The two-component handles are ergonomically shaped and offer best gripping and comfortable working. The diagonal cutting pliers are forged of a high-quality chrome-vanadium ball bearing steel.

All versions are electrically dissipative 

ESD diagonal cutting pliers E351TX

pointed jaws, handles ESD dissipative, blue grey, small bevel **with carbide cutting edges made of tungsten carbide, Swiss-made**

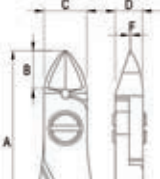

dpvlink 18397

Article	A [mm]	C [mm]	B [mm]	D [mm]	Cu wire [mm]
I-E351TX.ESD	123	12.5	7.5	6.4	0.3 -2.0



ESD diagonal cutting pliers 5140/41/42

oval jaws, handles ESD dissipative, blue grey, *Swiss-made*

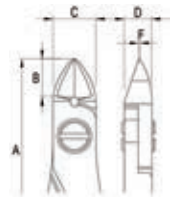

dpvlink 13235

Article	A [mm]	C [mm]	B [mm]	D [mm]	Cu wire [mm]
I-E5140.ESD	125	10	10	6.4	0.2 -1.2
I-E5141.ESD	125	10	10	6.4	0.1 -1.2
I-E5142.ESD	125	10	10	6.4	0.1 -1.0



ESD diagonal cutting pliers 5150/51/52

large, oval jaws, handles ESD dissipative, blue grey, *Swiss-made*

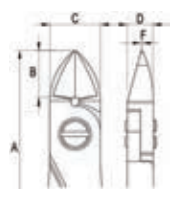

dpvlink 13239

Article	A [mm]	C [mm]	B [mm]	D [mm]	Cu wire [mm]
I-E5150.ESD	125	12.5	12.5	6.4	0.3 -1.6
I-E5151.ESD	125	12.5	12.5	6.4	0.2 -1.6
I-E5152.ESD	125	12.5	12.5	6.4	0.2 -1.2



ESD diagonal cutting pliers 5160/61/62

extra large, oval jaws, handles ESD dissipative, blue/grey, *Swiss-made*



dpvlink 16939

Article	A [mm]	C [mm]	B [mm]	D [mm]	Cu wire [mm]
I-E5160.ESD	130	16	14	6.4	0.4 -2.0
I-E5161.ESD	130	16	14	6.4	0.3 -1.6
I-E5162.ESD	130	16	14	6.4	0.3 -1.6





ESD diagonal cutting pliers 5340/41/42

small, pointed jaws, handles ESD dissipative, blue grey, *Swiss-made*



dpvlink 13243

Article	A [mm]	C [mm]	B [mm]	D [mm]	Cu wire [mm]
 I-E5340.ESD	125	10	10	6.4	0.2 -1.2
 I-E5341.ESD	125	10	10	6.4	0.1 -1.2
 I-E5342.ESD	125	10	10	6.4	0.1 -1.0



ESD diagonal cutting pliers 5247

Narrow head angled by 50°, handles ESD dissipative, blue grey, without bevel/flush cut, *Swiss-made*



dpvlink 15045

Article	A [mm]	C [mm]	B [mm]	D [mm]	Cu wire [mm]
 I-E5247.ESD	130	10	17	6.4	0.1 -1.2





ESD diagonal cutting pliers 5350/51/52

pointed jaws, handles ESD dissipative, blue grey, *Swiss-made*



dpvlink 13247

Article	A [mm]	C [mm]	B [mm]	D [mm]	Cu wire [mm]
 I-E5350.ESD	125	12.5	12.5	6.4	0.3 -1.6
 I-E5351.ESD	125	12.5	12.5	6.4	0.2 -1.6
 I-E5352.ESD	125	12.5	12.5	6.4	0.2 -1.2



ESD diagonal cutting pliers 5250

Large head angled by 45°, handles ESD dissipative, blue/grey, without bevel/flush cut, *Swiss-made*



dpvlink 16945

Article	A [mm]	C [mm]	B [mm]	D [mm]	Cu wire [mm]
 I-E5250.ESD	130	10	14.5	6.4	0.2 -1.2





ESD diagonal cutting pliers 5540/41/42

tapered, small, pointed jaws, handles ESD dissipative, blue grey, *Swiss-made*



dpvlink 13251

Article	A [mm]	C [mm]	B [mm]	D [mm]	Cu wire [mm]
 I-E5540.ESD	125	10	10	6.4	0.2 -1.2
 I-E5541.ESD	125	10	10	6.4	0.1 -1.2
 I-E5542.ESD	125	10	10	6.4	0.1 -0.8



Wire clamp / safety spring

Wire clamp / safety spring, Swiss-made, PU = 5 pieces



dpvlink 16226

Article	Type
I-WLC100	Wire clamp / safety spring suitable for diagonal cutting pliers type 5140/5141/5142 +5340/5341/5342 + 5540/5541/5542
I-WLC125	Wire clamp / safety spring suitable for diagonal cutting pliers type 5150/5151/5152 +5350/5351/5352



ideal-tek Long-nosed pliers ERGO-TEK Slim

The new, lightweight ERGO-TEK SLIM series has been designed for small hands - providing the same ergonomics, ESD safety and technical advantages that have always characterized ideal-tek.



Special features

- Ergonomic handle
- Slip-resistant surface
- Very lightweight
- Suitable for narrow spaces

ESD long-nosed pliers Slim 6021, 6022

short jaws (20 mm), ERGO-TEK Slim handles ESD dissipative, blue grey, *Swiss-made*



dpvlink 26768

Article	A [mm]	C [mm]	B [mm]	D [mm]
I-ES6021.ESD	130	10	20	6.4
I-ES6022.ESD	130	10	20	6.4

ESD long-nosed pliers Slim 6023, 6024

long jaws (30 mm), ERGO-TEK Slim handles ESD dissipative, blue grey, *Swiss-made*



dpvlink 26771

Article	A [mm]	C [mm]	B [mm]	D [mm]
I-ES6023.ESD	143	10	30	6.4
I-ES6024.ESD	143	10	30	6.4

ESD flat-nosed pliers Slim 6011, 6012

short jaws (20 mm), ERGO-TEK Slim handles ESD dissipative, blue grey, *Swiss-made*



dpvlink 26774

Article	A [mm]	C [mm]	B [mm]	D [mm]
I-ES6011.ESD	130	10	20	6.4
I-ES6012.ESD	130	10	20	6.4

ESD flat-nosed pliers Slim 6013, 6014

long jaws (30 mm), ERGO-TEK Slim handles ESD dissipative, blue grey, *Swiss-made*

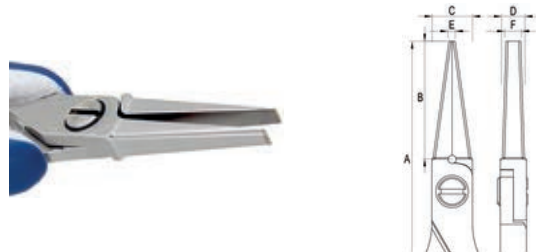

dpvlink 26777

Article	A [mm]	C [mm]	B [mm]	D [mm]
I-ES6013.ESD	143	10	30	6.4
I-ES6014.ESD	143	10	30	6.4

ESD round-nosed pliers Slim 6041

short jaws (24 mm), ERGO-TEK Slim handles ESD dissipative, blue grey, *Swiss-made*



dpvlink 26780

Article	A [mm]	C [mm]	B [mm]	D [mm]
I-ES6041.ESD	133	10	24	6.4

ideal-tek Long-nosed pliers ERGO-TEK

ideal-tek ERGO-TEK long-nosed pliers stand for highest requirements for material and handling. The tools are manufactured with high quality exclusively in Switzerland. A friction-less double spring ensures a smooth and soft opening. The two-components handles are ergonomically shaped and offer best gripping and comfortable working. The tools are forged from high-quality chromium-vanadium ball bearing steel. All versions are electrically dissipative ⚡

ESD flat-nosed pliers 6011



short jaws (20 mm), handles ESD dissipative, blue grey, *Swiss-made*

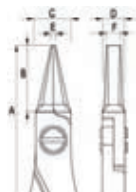

dpvlink 13255

Article	A [mm]	C [mm]	B [mm]	D [mm]	Cut
I-E6011.ESD	135	10	20	6.4	without cut
I-E6012.ESD	135	10	20	6.4	with cut



ESD flat-nosed pliers 6013, 6014



long jaws (30 mm), handles ESD dissipative, blue grey, *Swiss-made*

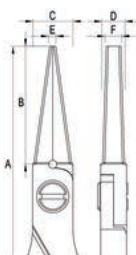

dpvlink 16203

Article	A [mm]	C [mm]	B [mm]	D [mm]	Cut
I-E6013.ESD	145	10	30	6.4	without cut
I-E6014.ESD	145	10	30	6.4	with cut



ESD long-nosed pliers 6021, 6022



short jaws (20 mm), handles ESD dissipative, blue grey, *Swiss-made*



dpvlink 13257

Article	A [mm]	C [mm]	B [mm]	D [mm]	Cut
I-E6021.ESD	135	10	20	6.4	without cut
I-E6022.ESD	135	10	20	6.4	with cut



ESD long-nosed pliers 6023, 6024



long jaws (30 mm), handles ESD dissipative, blue grey, *Swiss-made*



dpvlink 13260

Article	A [mm]	C [mm]	B [mm]	D [mm]	Cut
I-E6023.ESD	145	10	30	6.4	without cut
I-E6024.ESD	145	10	30	6.4	with cut



ESD round-nosed pliers 6041



short jaws (24 mm), handles ESD dissipative, blue grey, *Swiss-made*



dpvlink 13263

Article	A [mm]	C [mm]	B [mm]	D [mm]	Cut
I-E6041.ESD	140	10	24	6.4	without cut



Piergiacomini



All pliers are made of a special carbon steel.

The antireflecting phosphating metal surfaces ensure a safe, anti-fatigue working. The slip-resistant dolphin handle is made of two dissipative materials and created following ergonomic principles providing a safe, light and comfortable handling of the pliers. The patented return spring allows for a comfortable working. The suspension point when closing the cutting edges guarantees a longer shelf life of the cutting edges.

In compliance with the standard ESD DIN EN 6134-5-1

The cutting shapes and cutting performance:



With mini bevel (facet)

Nearly flush cut. Fine cutting edges. Suitable for soft steel wire, copper wire and cable.



With small bevel (facet)

Normal cut. Suitable for cutting hard and soft steel wires as well as soft materials such as copper wire and cable.



Without bevel (facet)

Flush cut. Extremely sharp cutting edges. Only suitable for soft steel wires, copper wire and cable.



Without bevel flush (facet)

Flush cut for soft materials.



With inverted bevel (facet)

After cutting 1.5 mm of the wire remain.

Diagonal cutting pliers series Evolution

Diagonal cutting pliers TRE-03-AB



Light and handy, for finer work even on thicker wires.

Length: 138 mm; small bevel

dpvlink 1573

Article	Bevel	Safety Spring	Max Cu	AWG
TRE-03-NB.D	small bevel		1.30 mm	16
TRE-03-AB.D	small bevel	AF	1.30 mm	16

Diagonal cutting pliers TR-25A.D



Light and handy, very good cutting properties.

Length: 138 mm; small bevel

dpvlink 1592

Article	Bevel	Safety Spring	Max Cu	AWG
TR-25.D	small bevel		1.30 mm	16
TR-25-A.D	small bevel	AF	1.30 mm	16

Diagonal cutting pliers TR-25-15



The cut lines leave a 1.5 mm protrusion from the work surface.

Length: 138 mm

dpvlink 1813

Article	Bevel	Max Cu	AWG
TR-25-15.D	reversed bevel	1.30 mm	16

Diagonal cutting pliers TR-25-L



As TR-25, but with long handles. Reduces the effort.

Length: 160 mm; small bevel

dpvlink 1819

Article	Bevel	Safety Spring	Max Cu	AWG
TR-25-L-A.D	small bevel	AF	1.30 mm	16

Diagonal cutting pliers TR-25-15-L



As TR-25-15, but with long handles. Less effort.

Length: 160 mm; reversed bevel

dpvlink 1821

Article	Bevel	Max Cu	AWG
TR-25-15-L.D	reversed bevel	1.30 mm	16

Diagonal cutting pliers TR-25-50



Light and handy, with cutting edges angled by 48° (to the handle).

Length: 135 mm; small bevel

dpvlink 1827

Article	Bevel	Max Cu	AWG
TR-25-50.D	small bevel	1.30 mm	16

Diagonal cutting pliers TR-25-L-25



With long handles, angled by 25° for a relief of the strain and for a better accessibility to tight surfaces.

Length: 160 mm; small bevel

dpvlink 1830

Article	Bevel	Safety Spring	Max Cu	AWG
TR-25-L-25-A.D	small bevel	AF	1.30 mm	16

Diagonal cutting pliers TR-30



More stable than the pliers TR-25, jaws offer more resistance.

Length: 138 mm; small bevel

dpvlink 1839

Article	Bevel	Safety Spring	Max Cu	AWG	QR
TR-30.D	small bevel		1.30 mm	16	
TR-30-A.D	small bevel	AL	1.30 mm	16	

Diagonal cutting pliers TR-30-58



Facilitates the cutting of iron wire.

Length: 138 mm; mini-bevel

dpvlink 1850

Article	Bevel	Safety Spring	Max Cu	AWG	QR
TR-30-58.D	mini bevel		1.63 mm	14	
TR-30-58-A.D	mini bevel	AL	1.63 mm	14	

Diagonal cutting pliers TR-30-58-R



as TR-30-58, but with small bevel

Length: 138 mm

dpvlink 1852

Article	Bevel	Safety Spring	Max Cu	AWG	QR
TR-30-58-R.D	small bevel		1.63 mm	14	
TR-30-58-R-A.D	small bevel	AL	1.63 mm	14	

Diagonal cutting pliers TR-58



More stable than TR-30-58. The cutting blades are also hardened.

Length: 138 mm; mini-bevel

dpvlink 1854

Article	Bevel	Safety Spring	Max Cu	AWG	QR
TR-58.D	mini bevel		2.05 mm	12	
TR-58-A.D	mini bevel	AL	2.05 mm	12	

Diagonal cutting pliers TRR-58 G



Light and handy for finer work also on thicker wires.

Length: 160 mm; small bevel

dpvlink 1862

Article	Bevel	Max Cu	AWG	QR
TRR-58-G.D	small bevel	2.59 mm	10	

Diagonal cutting pliers TR-58-R



as TR-58, but with small bevel

Length: 138 mm

dpvlink 1856

Article	Bevel	Safety Spring	Max Cu	AWG	QR
TR-58-R.D	small bevel		2.05 mm	12	
TR-58-R-A.D	small bevel	AL	2.05 mm	12	

Diagonal cutting pliers TRR-58



Stable construction. For cutting with high effort, even on hardest materials due to additionally hardened cutting edges.

Length: 160 mm; mini-bevel

dpvlink 1860

Article	Bevel	Safety Spring	Max Cu	AWG	QR
TRR-58.D	mini bevel		2.59 mm	10	
TRR-58-A.D	mini bevel	AL	2.59 mm	10	

Diagonal cutting pliers TRR-58-B



Due to the curved surface of the cutting edges, the cut parts are like "finish machined".

Length: 160 mm; small bevel

dpvlink 2304

Article	Bevel	Max Cu	AWG	QR
TRR-58-B.D	small bevel	2.05 mm	12	

End cutting pliers TR-30 V



Cutting edges angled by 30°, ideal for work on places that are particularly difficult to reach.

Length: 144 mm, reversed bevel

dpvlink 1864

Article	Bevel	Max Cu	AWG
TR-30-V.D	reversed bevel	1.02 mm	18



End cutting pliers TR-30-15-V



Cutting edges angled by 30°. The cut lines leave a 1.5 mm protrusion from the working surface.

Length: 144 mm, reversed bevel

dpvlink 1866

Article	Bevel	Max Cu	AWG
TR-30-15-V.D	reversed bevel	1.02 mm	18



Diagonal cutting pliers TR-30-15



Designed for the cutting of components at 1.5 mm from the working surface. The cut part remains completely flat.

Length: 138 mm, without bevel

dpvlink 1868

Article	Bevel	Max Cu	AWG
TR-30-15.D	without bevel, flush cut	1.30 mm	16



Special cutting pliers TR-30-T



Special pliers for cutting DIP pins (internal circuits). Cutting edges bent by 60°.

Length: 137 mm, without bevel

dpvlink 1870

Article	Bevel	Max Cu	AWG
TR-30-T.D	without bevel	1.02 mm	18



High-leverage diagonal cutting pliers TR-5000



Length: 138 mm; mini-bevel

dpvlink 1880

Article	Bevel	Safety Spring	Max Cu	AWG
TR-5000-A.D	mini bevel	AF	2.05 mm	12



High-leverage diagonal cutting pliers TR-5000-R



Length: 138 mm; mini-bevel

dpvlink 1882

Article	Bevel	Safety Spring	Max Cu	AWG
TR-5000-R-A.D	small bevel	AF	2.0 mm	12



High-leverage diagonal cutting pliers TR-5000-P



Length: 138 mm; mini-bevel

dpvlink 1895

Article	Bevel	Safety Spring	Max Cu	AWG
TR-5000-P-A.D	mini bevel	AF	1.30 mm	16



High-leverage diagonal cutting pliers TR-5000-PR



Length: 138 mm; mini-bevel

dpvlink 1897

Article	Bevel	Safety Spring	Max Cu	AWG
TR-5000-PR-A.D	small bevel	AF	1.30 mm	16



High-leverage diagonal cutting pliers TR-5000-PG



Due to the curved surface of the cutting edges, the cut parts are like "finish machined". Best suited for final processing in the plastics sector.

Length: 138 mm; small bevel

dpvlink 1924

Article	Bevel	Max Cu	AWG
TR-5000-PG.D	small bevel	1.02 mm	18



High-leverage diagonal cutting pliers TRR-5000



Length: 138 mm; mini-bevel

dpvlink 1926

Article	Bevel	Safety Spring	Max Cu	AWG
TRR-5000-A.D	mini bevel	AF	2.59 mm	10



Diagonal cutting pliers series Micron

Diagonal cutting pliers TR-20-M



Micron cutting pliers, very light, anatomically shaped. For the use in case of particularly difficult work.

Length 132 mm; small bevel

dpvlink 2100

Article	Bevel	Safety Spring	Max Cu	AWG
TR-20-M.D	small bevel		0.81 mm	20
TR-20-M-A.D	small bevel	AF	0.81 mm	20



Diagonal cutting pliers TR-25-P



Micron cutting pliers, very sharp cutting edges for extremely difficult work.

Length: 132 mm; small bevel

dpvlink 2103

Article	Bevel	Safety Spring	Max Cu	AWG
TR-25-P-A.D	small bevel	AF	1.02 mm	18



Diagonal cutting pliers TR-20-SM



Micron cutting pliers, same properties as TR-20-M, but with beveled edges.

Length: 132 mm; small bevel

dpvlink 2106

Article	Bevel	Max Cu	AWG
TR-20-SM.D	small bevel	0.81 mm	20



Diagonal cutting pliers TR-20-50-M



Micron cutting pliers with cutting edges angled by 50°. The very thin cutting heads are ideal for difficult to reach working areas.

Length: 131 mm; small bevel

dpvlink 2110

Article	Bevel	Max Cu	AWG
TR-20-50-M.D	small bevel	0.64 mm	22



Diagonal cutting pliers TR-20-TM



Micron cutting pliers with cutting edges angled by 50°. Designed for cutting DIP pins.

Length: 129 mm; small bevel

dpvlink 2118

Article	Bevel	Max Cu	AWG
TR-20-TM.D	small bevel	0.64 mm	22



End cutting pliers TR-20-VM



Micron cutting pliers, angled by 60°, for cutting on tight surfaces.

Length: 132 mm; small bevel 60° inclination

dpvlink 2120

Article	Bevel	Max Cu	AWG
TR-20-VM.D	small bevel	0.64 mm	22



Long-nosed pliers Piergiacomi

Pointed long-nosed pliers PN-20-M.D



Micron pliers, very light, anatomically shaped. For very difficult work. Jaws with short, smooth tips.

Length: 136 mm

dpvlink 2136

Article	Cut	Jaw length	Gripping surface	Tip	Thickness
PN-20-M.D	without cut	12 mm	smooth	1.0 mm	0.5 mm

Pointed long-nosed pliers PN-2002-M.D



Micron pliers for the miniaturization on rounded outer edges for working on particularly tight surfaces. Jaws with smooth tips and rounded outside.

Length: 146 mm

dpvlink 2151

Article	Cut	Jaw length	Gripping surface	Tip	Thickness
PN-2002-M.D	without cut	16 mm	smooth	1.2 mm	1.0 mm

Pointed long-nosed pliers PN-2002-PM.D



Micron pliers with long jaws, rounded outside and angled by 45° for very difficult work.

dpvlink 2155

Article	Cut	Jaw length	Gripping surface	Tip	Thickness
PN-2002-PM.D	without cut	16 mm	smooth	1.0 mm	0.5 mm

Short long-nosed pliers



For the general processing of components.

Length: 146 mm

dpvlink 26599

Article	Cut	Jaw length	Gripping surface	Tip	Thickness
PN-2001.D	without cut	16 mm	serrated	1.2 mm	1.0 mm
PN-2002.D	without cut	16 mm	smooth	1.2 mm	1.0 mm

Short long-nosed pliers



For the general processing of components.

Length: 146 mm

dpvlink 26604

Article	Cut	Jaw length	Gripping surface	Tip	Thickness
PN-5001.D	with cut	19 mm	serrated	2.0 mm	1.25 mm
PN-5002.D	without cut	19 mm	smooth	2.0 mm	1.25 mm

Long-nosed pliers



Due to the special shape (extended jaws) particularly suitable for working in narrow and difficult places.

Length: 160 mm

dpvlink 26600

Article	Cut	Jaw length	Gripping surface	Tip	Thickness
PN-2005.D	with cut	28 mm	serrated	1.2 mm	1.0 mm
PN-2006.D	without cut	28 mm	smooth	1.2 mm	1.0 mm

Long-nosed pliers



Due to the special shape (extended jaws) particularly suitable for working in narrow and difficult places.

Length: 160 mm

dpvlink 26605

Article	Cut	Jaw length	Gripping surface	Tip	Thickness
PN-5005.D	with cut	25 mm	serrated	2.0 mm	1.25 mm
PN-5006.D	without cut	25 mm	smooth	2.0 mm	1.25 mm

Round long-nosed pliers



For the general processing of components.

Length: 154 mm

dpvlink 2278

Article	Cut	Jaw length	Gripping surface	Tip	Thickness
PN-5025.D	without cut	26 mm	smooth		1.8 mm
PN-5025-Z.D	with cut	26 mm	serrated		1.8 mm

Round long-nosed pliers



For the general processing of components.

Length: 160 mm

dpvlink 26603

Article	Cut	Jaw length	Gripping surface	Tip	Thickness
PN-2015.D	with cut	28 mm	serrated	1.2 mm	1.0 mm
PN-2016.D	without cut	28 mm	smooth	1.2 mm	1.0 mm

Angled long-nosed pliers



Suitable for the component processing in nearly all difficult places, with 45° angle, thus there is an excellent insight on to the place which is to be worked on.

Length: 152 mm

dpvlink 2241

Article	Cut	Jaw length	Gripping surface	Tip	Thickness
PNB-2005.D	with cut	16 mm	serrated	1.2 mm	1.0 mm
PNB-2006.D	without cut	16 mm	smooth	1.2 mm	1.0 mm

Angled, rounded long-nosed pliers



Angled long-nosed pliers. Rounded jaws to avoid damages of components in narrow places.

Length: 152 mm

dpvlink 2259

Article	Cut	Jaw length	Gripping surface	Tip	Thickness
PNB-2015.D	with cut	16 mm	serrated	1.2 mm	1.0 mm
PNB-2016.D	without cut	16 mm	smooth	1.2 mm	1.0 mm



Special tools Piergiacomì

High-leverage end cutting pliers TP-5000/15.D



The component is cut, bent and blocked on the PCB at the same time in one single operation. Length 147 mm, max. CU-Ø 1.02 mm, 18 AWG, cut: front cut

dpvlink 2307

Article	L [mm]	Max Cu	AWG
TP-5000/15.D	147 mm	0.8 mm	20



Bending pliers PNR-30.D



Specially designed for the forming of cables in a C shape. Length 145 mm, max. CU-Ø 1.02 mm, 18 AWG

dpvlink 2309

Article	L [mm]	Max Cu	AWG
PNR-30.D	145 mm	0.8 mm	20



Bending and cutting pliers PTR-30-C.D



Specially designed for the forming of cables in a C shape and for the cutting of the remaining parts. Length 150 mm, max. CU-Ø 1.02 mm, 18 AWG

dpvlink 2333

Article	L [mm]	Max Cu	AWG
PTR-30-C.D	150 mm	0.8 mm	20



Bending and cutting pliers PTR-30-L.D



Specially designed for the forming of wires in an L shape and for the cutting of the remaining parts. Length 150 mm, max. CU-Ø 1.02 mm, 18 AWG

dpvlink 2335

Article	L [mm]	Max Cu	AWG
PTR-30-L.D	150 mm	1.02 mm	18



Bending and crimping pliers PNR-5000.D



Specially designed for the crimping and cutting of components in one operation. With adjustable stop. Length 150 mm. Max CU Ø 1.0 mm, 18 AWG

dpvlink 2361

Article	L [mm]	Max Cu	AWG
PNR-5000.D	150 mm	0.8 mm	20



Cutting and crimping pliers PNR-5010.D

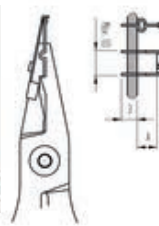

Cutting and crimping pliers, ESD version DIN 61340-5-1

dpvlink 17939

Article	L [mm]	Max Cu	AWG
PNR-5010.D	150 mm	0.8	20



Special pliers PNG-5000.D



Special pliers, developed for the forming of the components in a C shape. Its special radius allows a stress-free forming of components. Length 150mm. Max CU Ø 1.02 mm, 18 AWG

dpvlink 2359

Article	L [mm]	Max Cu	AWG
PNG-5000.D	150 mm	0.8 mm	20



Bending pliers PPR-5001.D / PPR-5002.D / PPR-5003.D



Specially designed for the bending of components
Length 150mm

dpvlink 2363



Article	L [mm]	A	Max Cu	AWG
PPR-5001.D	150 mm	10.16 mm	0.6 - 0.8 mm	22 - 20
PPR-5002.D	150 mm	12.70 mm	0.6 - 0.8 mm	22 - 20
PPR-5003.D	150 mm	15.24 mm	0.6 - 0.8 mm	22 - 20

Special bending pliers 90° PN-5040/7.D

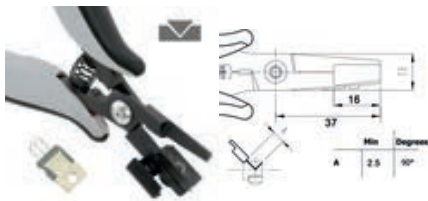

Specially designed for bending of radial components at an angle of 90°. Length 150 mm, max. CU-Ø 1.30 mm, 16 AWG

dpvlink 18290



Article	L [mm]	Max Cu	AWG
PN-5040/7.D	158 mm	1.30 mm	16

Special pliers SMD PNI-5000.D



Specially designed for bending and cutting SMD IC pins.
Length 150 mm
Max CU Ø 0.80 mm, 20 AWG

dpvlink 2351



Article	L [mm]	Max Cu	AWG
PNI-5000.D	150 mm	0.8 mm	20

Cutting pliers PNI-5015.D

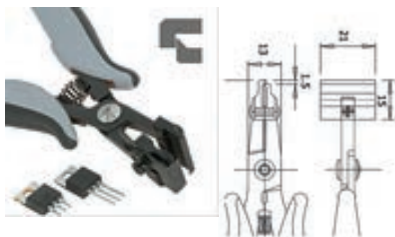

Cutting pliers, adjustable cutting length
1.5 mm - max. 10 mm, ESD version DIN EN 61340-5-1

dpvlink 17937



Article	L [mm]	Max Cu	AWG
PNI-5015.D	155	0.64 mm	22

Bending pliers TO-220

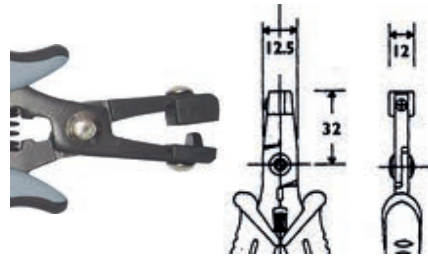

Specially designed to form a lead of TO-220 housings etc.

dpvlink 2353



Article	Type
PN-5050/10.D	Bending pliers TO-220 side lead formed 2.54 mm length 158 mm
PN-5050/14.D	Bending pliers TO-220 central lead formed 3.00 mm length 158 mm
PN-5050/15.D	Bending pliers TO-220 central lead formed 2.50 mm length 158 mm
PN-5050/16.D	Bending pliers TO-220 side lead formed 3.81 mm length 158 mm
PN-5050/17.D	Bending pliers TO-220, 90° central lead formed 3.81 mm length 158 mm
PN-5050/19.D	Bending pliers TO-220 90° with 5 pins leads 1+3+5 formed 4 mm and 2+4 1.50 mm length 158 mm
PN-5050/21.D	Bending pliers TO-220 90° with 5 pins leads 2+4 formed 2.54 mm length 155 mm
PN-5050/25.D	Bending pliers TO-92 Pin spacing 1.27 mm, central lead formed 1.27 mm length 158 mm
PN-5050/36.D	Bending pliers TO-220 with 5 pins leads 2+4 formed 3.00 mm length 158 mm
PN-5050/37.D	Bending pliers TO-220 90° with 5 pins leads 1+3+5 formed 2.54 mm length 155 mm
PN-5050/38.D	Bending pliers TO-220 with 5 pins leads 1+3+5 formed 3.00 mm length 158 mm

dpvlink 2353



Article
Type

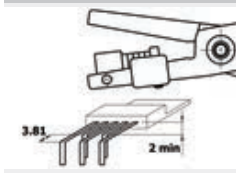

PN-5050/46.D
Bending pliers TO-220 90° with 5 pins
leads 1+3+5 formed 3.81 mm
length 155 mm

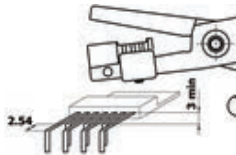

PN-5050/47.D
Bending pliers TO-92 90° with 7 pins
leads 1+3+5+7 formed 2.54 mm
length 155 mm

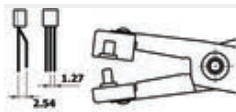

PN-5050/49.D
Bending pliers TO-92
Pin spacing 1.27 mm, central lead formed 2.54 mm
length 158 mm

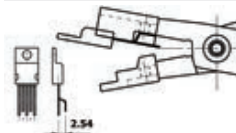

PN-5050/53.D
Bending pliers TO-220 with 5 pins
leads 2+4 formed 2.54 mm
length 158 mm

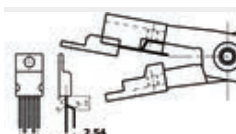

PN-5050/54.D
Bending pliers TO-220 avec 5 pins
leads 1+3+5 formed 2.54 mm
length 158 mm

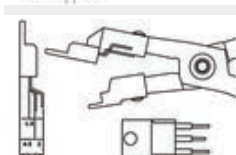

PN-5050/60.D
Bending pliers TO-220
side lead formed 1.50 mm, centra lead formed 3.50 mm
length 158 mm

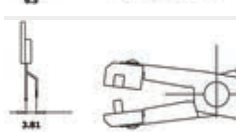

PN-5050.D
Bending pliers TO-220, 90°
central lead formed 3.81 mm
Length 158 mm



PN-5050/3.D
Bending pliers TO-220, 90°
central lead formed 5.08 mm
Length 158 mm

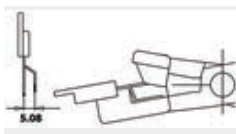

PN-5050/4.D
Bending pliers TO-220, 90°
side lead formed 5.08 mm
Length 158 mm

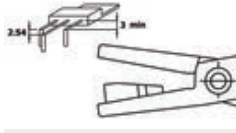

PN-5050/6.D
Bending pliers TO-220, 90°
Length 155 mm

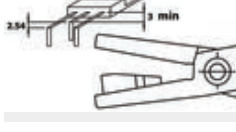

PN-5050/7.D
Bending pliers TO-220, 90°
Length 155 mm

Special pliers for PLCC



Specially designed for safe extraction of PLCC components. Length 142 mm

dpvlink 2338



Article Type

PLCC-32	Special pliers for PLCC 32 pins
PLCC-44	Special pliers for PLCC 44 pins
PLCC-52	Special pliers for PLCC 52 pins
PLCC-68	Special pliers for PLCC 68 pins
PLCC-84	Special pliers for PLCC 84 pins

Special cutting pliers TS-30



Special pliers for the electronics. In only a single operation, the component is cut, bent and at the same time blocked on the printed circuit board.

Length: 138 mm

dpvlink 1872



Article	Max Cu	AWG
TS-30.D	1.02 mm	18

Special cutting pliers TP-30



Special pliers for the electronics. In only a single operation, the component is cut, bent and at the same time blocked on the printed circuit board.

Length: 138 mm

dpvlink 1874



Article	Max Cu	AWG
TP-30.D	1.02 mm	18

Shears CS-30



Extremely handy shears, for the use in the electronics, can also be used in many other areas.

Length: 144 mm

dpvlink 1878



Article	Max Cu	AWG
CS-30.D	1.30 mm	16

CK Pliers SensoPlus



The current composition of shape and technology, completely convincing.

A flowing line adapted to the natural form of the hand in the right proportions.

The guarantee for a fatigue-free, controlled, safe and fast working in a level of quality that has been unknown up to now.



Ergonomics in an optimum design.

1. Two-component handle with flush, soft thermoplastic material, slip-resistant and comfortable.
2. Slip protection for a controlled and concentrated work.
3. Captive, welded double leaf spring: guarantees an optimal function for the whole service life.
4. Precise box joint: accurate guiding of the jaws without readjustment in case of a long service life.
5. Mirror polish: optimal protection against corrosion without chrome, easy to clean.
6. Inductive hardening of cutting edges: high hardness for a long durability.

The shapes of cutting edges and cutting performance



With small bevel (facet)

Normal cut. Suitable for cutting hard and soft steel wires as well as soft materials such as copper wire and cable.



With large bevel (facet)

Suitable for cutting hard and very hard steel wires. Long service life.



Without bevel (facet)

Flush cut. Extremely sharp cutting edges. Only suitable for soft steel wires, copper wire and cable.

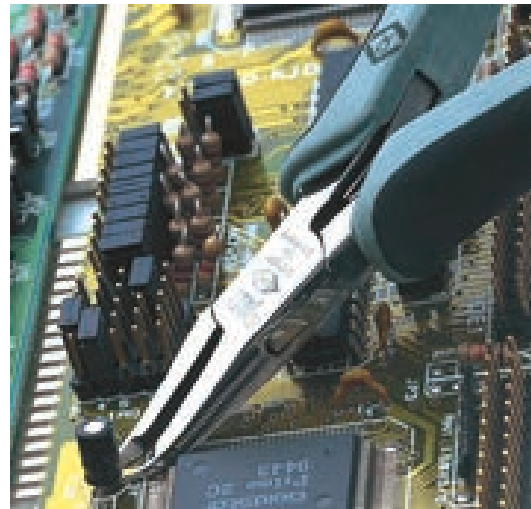

Made in Germany

Diagonal cutting pliers 3880



dpvlink 1440

Article	Bevel	Ø soft/AWG	Ø medium/AWG	Ø piano/AWG
3880DF-110	without bevel	1.5 / 15	1.0 / 20	0.4 / 26
3880DEF-110	without bevel	1.0 / 18	0.6 / 22	- / -

Oblique cutting pliers 3786



Narrow head. For tight spaces; small bevel



dpvlink 1753

Article	Bevel	Ø soft/AWG	Ø medium/AWG
3786DF-120	small bevel	0.8 / 20	0.6 / 22

Oblique cutting pliers 3871



Extra slim, long jaws. For very narrow spaces. Also for SMD applications; small bevel

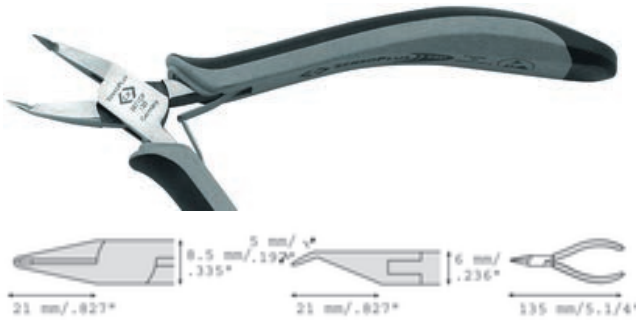

dpvlink 1755

Article	Bevel	Ø soft/AWG	Ø medium/AWG
3871DF-120	small bevel	0.8 / 20	0.6 / 22



Diagonal cutting pliers 3766-110



Pointed and flattened head. Also for SMD applications.



dpvlink 1710

Article	Bevel	Ø soft/AWG	Ø medium/AWG
3766DF-110	small bevel	1.5 / 15	0.8 / 20
3766DEF-110	without bevel	1.5 / 15	0.6 / 22



Diagonal cutting pliers 3780



Pointed head.



dpvlink 1717

Article	Bevel	Ø soft/AWG	Ø medium/AWG
3780DF-110	small bevel	1.5 / 15	0.8 / 20
3780DEF-110	without bevel	1.0 / 18	0.6 / 22



Diagonal cutting pliers 3773



Oval head

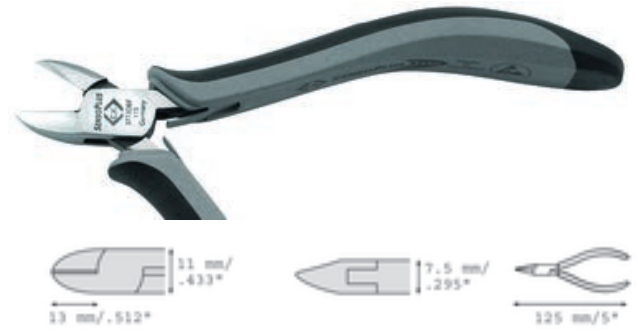

dpvlink 1725

Article	Bevel	Ø soft/AWG	Ø medium/AWG	Ø hard/AWG
3773D-115	large bevel	1.5 / 15	1.0 / 18	0.4 / 26
3773DF-115	small bevel	1.5 / 15	1.0 / 18	- / -
3773DEF-115	without bevel	1.5 / 15	1.0 / 20	- / -



Diagonal cutting pliers 3779



Oval head. Carbide cutting edges, not for soft material



dpvlink 1729

Article	Bevel	Ø soft/AWG	Ø hard/AWG	Ø piano/AWG
3779D-115	large bevel	2.0 / 12	1.0 / 18	0.6 / 22



Oblique cutting pliers 3799



Cut surface angled by 29°
Horizontal and vertical operation, stable and handy

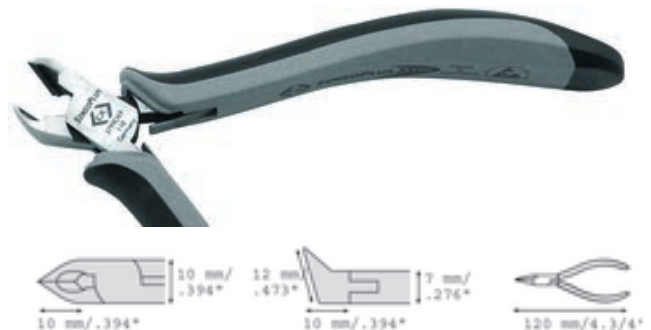

dpvlink 1731

Article	Bevel	Ø soft/AWG	Ø medium/AWG	Ø hard/AWG
3799DF-110	small bevel	1.0 / 16	1.0 / 18	0.4 / 26
3799DEF-110	without bevel	1.0 / 18	0.8 / 20	- / -



Diagonal cutting pliers 3782



Oval head. With wire holder.



dpvlink 1734

Article	Bevel	Ø soft/AWG	Ø medium/AWG
3782DEF-115	without bevel	1.5 / 15	0.8 / 20



Diagonal cutting pliers 3781



Pointed head.



dpvlink 1745

Article	Bevel	Ø soft/AWG	Ø medium/AWG	Ø hard/AWG
3781D-115	large bevel	1.5 / 15	1.0 / 18	0.3 / 28
3781DF-115	small bevel	1.5 / 15	0.8 / 18	- / -
3781DEF-115	without bevel	1.5 / 15	0.8 / 20	- / -



Diagonal cutting pliers 3787



Pointed head, for narrow spaces; carbide cutting edges.



dpvlink 10555

Article	Bevel	Ø soft/AWG	Ø hard/AWG	Ø piano/AWG
3787DF-115	small bevel	1.8 / 13	1.0 / 18	0.4 / 22



Oblique cutting pliers 3778



dpvlink 21270

Article	Bevel	Ø soft/AWG	Ø medium/AWG	Ø hard/AWG
3778DF	small bevel	1,6 / 14	1,2 / 16	0,5 / 24



End cutting pliers 3784



dpvlink 21272

Article	Bevel	Ø soft/AWG	Ø medium/AWG
3784DF	small bevel	0.8 / 20	0.6 / 22



Diagonal cutting pliers



Pointed and flattened head



dpvlink 1721

Article	Bevel	Ø soft/AWG	Ø medium/AWG
3766DEF-120	without bevel	1.5 / 15	0.6 / 22



Diagonal cutting pliers 3775



Head oval



dpvlink 21260

Article	Bevel	Ø soft/AWG	Ø medium/AWG	Ø hard/AWG
---------	-------	------------	--------------	------------

3775D-135	large bevel	2.0 / 12	1.5 / 15	0.7 / 21
-----------	-------------	----------	----------	----------



Long-nosed pliers 3767



Bent



dpvlink 1761

Article	Type
---------	------

3767D-120	Long-nosed pliers without cut
-----------	-------------------------------



End cutting pliers 3776



dpvlink 21267

Article	Bevel	Ø soft/AWG	Ø medium/AWG
---------	-------	------------	--------------

3776DEF-115	without bevel	2.0 / 12	1.6 / 14
-------------	---------------	----------	----------



Flat-nose pliers 3770



dpvlink 1765

Article	Type
---------	------

3770D-120	Flat-nose pliers without cut
-----------	------------------------------



3770-1D-120	Flat-nose pliers with cut
-------------	---------------------------



Long-nosed pliers 3772-120



Straight

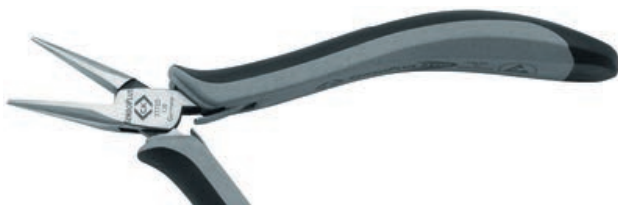

dpvlink 1476

Article	Type
---------	------

3772D-120	Long-nosed pliers without cut
-----------	-------------------------------



3772-1D-120	Long-nosed pliers with cut
-------------	----------------------------



Round-nosed pliers 3771



dpvlink 1770

Article	Type
---------	------

3771D-120	Round-nosed pliers without cut
-----------	--------------------------------



Long-nosed pliers



Straight

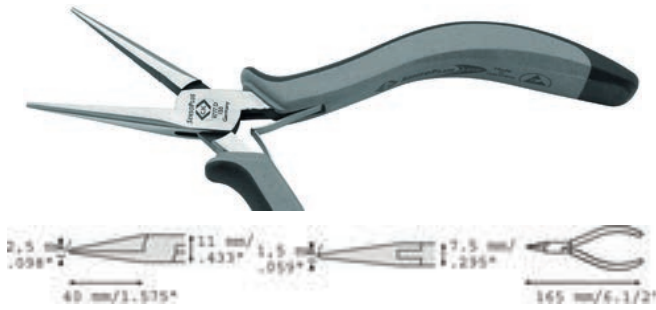

dpvlink 1772

Article Type

3777D-150 Long-nosed pliers with cut



Long-nosed pliers 3769



Bent

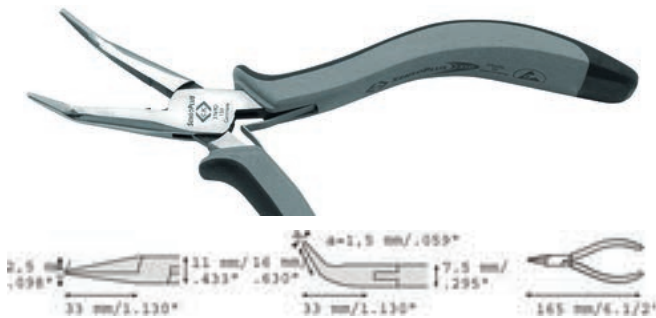

dpvlink 1775

Article Type

3769D-150 Long-nosed pliers with cut



Needle-nose pliers 3783



Straight, extra slim jaws and very fine tips

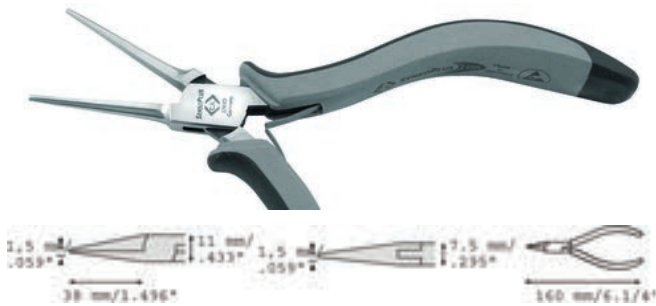

dpvlink 1778

Article Type

3783D-145 Needle-nose pliers without cut



Pliers set in tool bag



6-piece ESD pliers set in service bag. Service bag made of synthetic leather with zipper. 6 compartments for pliers of up to 120 mm length. Dimensions approx. 180 x 145 x 45 mm.



Content consisting of:

- Long-nosed pliers, straight 3772D-120
- Flat-nose pliers 3770D-120
- Diagonal cutting pliers 3773DF-115
- Diagonal cutting pliers 3880D-110
- Diagonal cutting pliers 3766DF-120
- Oblique cutting pliers 3786DF-120

dpvlink 1784

Article Type

3703D 6-piece pliers set in service bag



ESD tool set 14-piece



14-piece ESD tool set in service case. Compact service case with stable foam inserts (no ESD material), approx. 260 x 200 x 60 mm

Content consisting of:

- Long-nosed pliers straight 3772D-120
- Diagonal cutting pliers 3773D-115
- SMD placement tweezers 2334, 2343
- Precision tweezers 2343
- XonicXM slotted screwdriver 4880XESD 0.8 x 60 to 2.5x75
- Phillips screwdriver 4882XESD PH PH 1 x 80 000 x 60

dpvlink 14187

Article Type

3707DX.ESD 14-piece ESD tool set



CK diagonal cutting pliers Ecotronic

Diagonal cutting pliers 3883



Small, slim and angled head



dpvlink 21274

Article	Bevel	AWG	Max Cu	L [mm]
3883.ESD	without bevel	16	1.3 mm	132



Diagonal cutting pliers 3884

Small, slim, angled head. Inside cutting.



dpvlink 21276

Article	Bevel	AWG	Max Cu	L [mm]
3884.ESD	without bevel	16	1.3 mm	132



Diagonal cutting pliers 3885

Small, slim, angled head



dpvlink 21278

Article	Bevel	AWG	Max Cu	L [mm]
3885.ESD	without bevel	16	1.3 mm	139



Diagonal cutting pliers 3886

Slim, flattened, angled head.



dpvlink 21280

Article	Bevel	AWG	Max Cu	L [mm]
3886.ESD	without bevel	16	1.3 mm	139



Diagonal cutting pliers 3887

with angled head



dpvlink 21282

Article	Bevel	AWG	Max Cu	L [mm]
3887.ESD	without bevel	14	1.6 mm	136



Diagonal cutting pliers 3888

with angled head and safety spring



dpvlink 21284

Article	Bevel	AWG	Max Cu	L [mm]
3888.ESD	without bevel	14	1.6 mm	135



CK pliers Ecotronic

ESD needle-nosed pliers 3889



dpvlink 21286

Article	Cut	L [mm]
3889.ESD	without cut	152



ESD needle-nosed pliers 3890



dpvlink 21288

Article	Cut	L [mm]
---------	-----	--------



3890.ESD	without cut	145
----------	-------------	-----

ESD flat-nosed pliers 3891



dpvlink 21290

Article	Cut	L [mm]
---------	-----	--------



3891.ESD	without cut	145
----------	-------------	-----

ESD needle-nosed pliers 3892



dpvlink 21292

Article	Cut	L [mm]
---------	-----	--------



3892.ESD	with cut	152
----------	----------	-----

Wiha

Wiha Professional ESD is ideal for the electronics professional who depends on precise and robust pliers.

The secret of success of the pliers series is as simple as ingenious: on the pliers head an uncompromising sharpness and hardness for a flush cutting, on the handle, however, the pleasant comfort for a stable, fatigue-free gripping, holding and cutting.

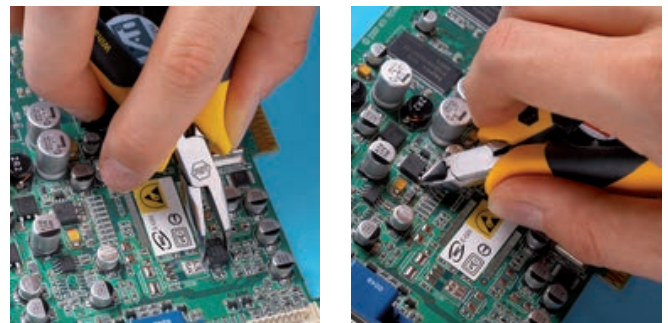

Special features:

- **ESD safe**
Suitable for working at ESD workstations according to IEC 61340-5-1
Surface resistance $10^6 - 10^9$ ohm
- **Antistatic**
Unique - dissipative properties in all components of the handle
- **Precise**
Box joint, safe against twisting
- **Hard as steel**
Pliers head die-forged made of high-quality steels
- **Robust and durable**
Cutting edges individually tempered and quenched, in addition inductively hardened to approx. 64 HRC. Joint extremely low-wear and highly resistant, high-quality riveting
- **Ergonomic**
Extra wide handle back, hard and soft zones perfectly distributed in the handle
- **Attractive**
Attractive design, with finely polished head

The cutting shapes and cutting performance:



With small bevel (facet)

Normal cut. Suitable for cutting hard and soft steel wires as well as soft materials such as copper wire and cable.



With large bevel (facet)

Suitable for cutting hard and very hard steel wires. Long service life.



Without bevel (facet)

Flush cut. Extremely sharp cutting edges. Only suitable for soft steel wires, copper wire and cable.

Wiha Pliers professional

Diagonal cutting pliers

Diagonal cutting pliers, narrow, pointed shape

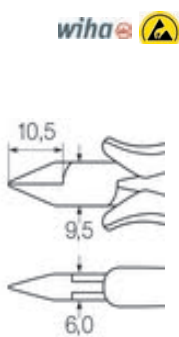

dpvlink 6358

Article	Bevel	L [mm]	Head width	Max Cu	AWG
Z40.1115.04	large bevel	115 mm	10.0 mm	1.0 mm	18
Z40.4115.04	small bevel	115 mm	10.0 mm	1.0 mm	18
Z40.3115.04	without bevel	115 mm	10.6 mm	1.0 mm	18

Diagonal cutting pliers

Diagonal cutting pliers, broad pointed shape

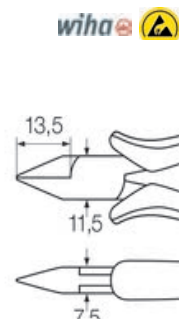

dpvlink 17963

Article	Bevel	L [mm]	Head width	Max Cu	AWG
Z41.1115.04	large bevel	115 mm	11.0 mm	1.4 mm	16
Z41.4115.04	small bevel	115 mm	11.0 mm	1.2 mm	18
Z41.3115.04	without bevel	115 mm	11.0 mm	1.0 mm	18

Diagonal cutting pliers

Diagonal cutting pliers, semicircular shape

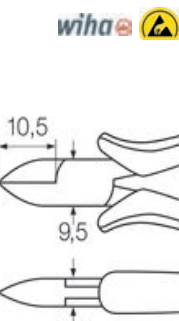

dpvlink 6364

Article	Bevel	L [mm]	Head width	Max Cu	AWG
Z43.1115.04	small bevel	115 mm	10.0 mm	1.2 mm	18
Z44.1115.04	large bevel	115 mm	11.0 mm	1.4 mm	16
Z44.3115.04	small bevel	115 mm	11.0 mm	1.2 mm	18

Oblique end cutting pliers

Oblique end cutting pliers, wide head, angled by 29°, small bevel

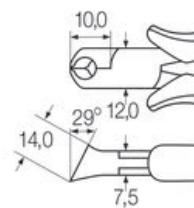

dpvlink 6380

Article	Bevel	L [mm]	Head width	Max Cu	AWG
Z46.1115.04	small bevel	115 mm	12.0 mm	1.2 mm	18

Oblique end cutting pliers

Oblique end cutting pliers extra narrow, slim shape, small bevel

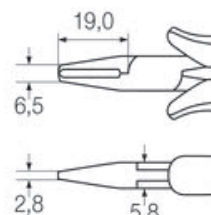

dpvlink 6377

Article	Bevel	L [mm]	Head width	Max Cu	AWG
Z47.1110.04	small bevel	110 mm	4.8 mm	0.6 mm	24

End cutting pliers, wide head

End cutting pliers, wide head, small bevel

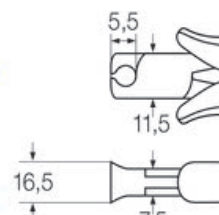

dpvlink 6382

Article	Bevel	L [mm]	Head width	Max Cu	AWG
Z47.2115.04	small bevel	115 mm	11.0 mm	1.4 mm	16

Plier set Wiha Professional ESD, 5-piece incl. tool bag



Pliers set professional ESD, 5-piece consisting of:

- Z41.3115.04 Diagonal cutting pliers Professional ESD - large, pointed head, without bevel
- Z44.1115.04 Diagonal cutting pliers Professional ESD - large, semicircular head, large bevel
- Z46.1115.04 Oblique end cutting pliers Professional - large head 29°, angled, small bevel
- Z36.0120.04 Taper-nose pliers Professional ESD - straight ESD tool bag

dpvlink 13278

Article	Type
Z99000104.ESD	Plier set Wiha ESD, 5-piece incl. tool bag



Tool set ESD 10 pieces



Tool set ESD, 10 pieces consisting of:

- Z36.0120.04 Taper-nose pliers Professional ESD - straight
 - Z41.3115.04 Diagonal cutting pliers Professional ESD - wide, pointed head without bevel
 - ZP.01014130 Universal tweezers Professional ESD typ AA
 - 270P.40x2.0 Slotted screwdriver PicoFinish® ESD 2 x 40 mm
 - 270P.50x2.5 Slotted screwdriver PicoFinish® ESD 2,5 x 50 mm
 - 271P.PH0x50 Phillips screwdriver PicoFinish® ESD PH0 x 50 mm
 - 271P.PH00x40 Phillips screwdriver PicoFinish® ESD PH00 x 40 mm
 - 277P.TX05x40 TORX® screwdriver PicoFinish® ESD T5 x 40 mm
 - 277P.TX06x40 TORX® screwdriver PicoFinish® ESD T6 x 40 mm
- ESD tool bag

dpvlink 24879

Article	Type
43994	Wiha tool set ESD 10 pieces with tool bag



Needle-nosed pliers, straight head



Needle-nosed pliers, straight head, fine semicircular tips with cut



dpvlink 6384

Article	L [mm]	W [mm]
Z36.0120.04	120 mm	9.5 mm
Z36.0145.04	120 mm	12.0 mm



Needle-nosed pliers, bent



Needle-nosed pliers, bent by 45°, without cut, fine semicircular tips



dpvlink 6386

Article	L [mm]	W [mm]
Z36.1120.04	120 mm	9.5 mm



Round-nose pliers



Round-nose pliers, round, short jaws



dpvlink 6388

Article	L [mm]	W [mm]
Z37.0120.04	120 mm	9.5 mm



Flat-nose pliers



Flat-nose pliers, without cut, flat and short jaws



dpvlink 6390

Article	L [mm]	W [mm]
Z38.0120.04	120 mm	9.5 mm



Knipex



Knipex pliers comply with the highest requirements concerning performance, ergonomics, and service life.

Due to a special selection of the used steels and the careful and high-quality processing, the Knipex pliers achieve an optimal durability and service life. Innovative ideas always offer forward-looking solutions for an easy, effective and safe working.

The cutting shapes and cutting performance:



With mini bevel (facet)

Nearly flush cut. Fine cutting edges. Suitable for soft steel wire, copper wire and cable.



With small bevel (facet)

Normal cut. Suitable for cutting hard and soft steel wires as well as soft materials such as copper wire and cable.



With large bevel (facet)

Suitable for cutting hard and very hard steel wires. Long service life.



Without bevel (facet)

Flush cut. Extremely sharp cutting edges. Only suitable for soft steel wires, copper wire and cable.



Without bevel flush (facet)

Flush cut for soft materials.

Knipex "Super Knips" series

The Knipex Super-Knips series have precision-ground cutting edges for a clean, planar cutting without bevel, e.g. for the use in electronics and fine mechanics. The very smooth-running joint and the opening spring offer high ease of use.

All versions are electrically dissipative ⚠️

Diagonal cutting pliers 7803125 ESD



Diagonal cutting pliers, head made of INOX stainless steel, without bevel, cutting hardness approx. 54 HRC.

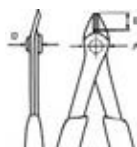

dpvlink 8830

Article	A [mm]	B [mm]	D [mm]	Cu wire [mm]
K-7803.125.ESD	13.5	9.0	7.5	0.2 -1.6



Diagonal cutting pliers 7813125 ESD



Diagonal cutting pliers, head made of INOX stainless steel, without bevel, with wire clamp/safety spring, cutting hardness approx. 54 HRC.



dpvlink 8831

Article	A [mm]	B [mm]	D [mm]	Cu wire [mm]
K-7813.125.ESD	13.5	9.0	7.5	0.2 -1.6



Diagonal cutting pliers 7861125 ESD



Diagonal cutting pliers, head of special tool steel, burnished, without bevel; cutting hardness approx. 64 HRC



dpvlink 8832

Article	A [mm]	B [mm]	D [mm]	Cu wire [mm]
K-7861.125.ESD	13.5	9.0	7.5	0.2 -1.6



Diagonal cutting pliers 7871125 ESD



Diagonal cutting pliers, head made of special tool steel, burnished, without bevel, with wire clamp/safety spring, hardness approx. 64 HRC

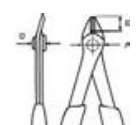

dpvlink 8833

Article	A [mm]	B [mm]	D [mm]	Cu wire [mm]
K-7871.125.ESD	13.5	9.0	7.5	0.2 -1.6



Diagonal cutting pliers 7803140 ESD



Diagonal cutting pliers, head of INOX stainless steel, without bevel, avec opening spring and opening limitation, cutting hardness approx. 54 HRC



dpvlink 21473

Article	A [mm]	B [mm]	D [mm]	Cu wire [mm]
K-7803.140.ESD	15.7	12.3	9.2	0.2 -2.1



Diagonal cutting pliers 7861140 ESD



Diagonal cutting pliers, head of special tool steel, burnished, without bevel, avec opening spring and opening limitation, cutting hardness approx. 64 HRC



dpvlink 21475

Article	A [mm]	B [mm]	D [mm]	Cu wire [mm]
K-7861.140.ESD	15.7	12.3	9.2	0.2-2.1



Knipex "Standard" series

The cutting pliers of the Knipex standard series are equipped with precision-ground cutting edges for finest cutting work, e.g. in electronics and fine mechanics. A low-friction double spring ensures a smooth and even opening. The mirror polish combined with a fine oil film offers a good rust protection so that errors in circuits by flaking chrome parts are prevented.

All versions are electrically dissipative

Flat-nose pliers 3512115 ESD



Flat-nose pliers, flat, wide jaws, gripping surfaces smooth.

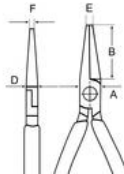

dpvlink 8834

Article	A [mm]	B [mm]	D [mm]	E [mm]	F [mm]
K-3512.115.ESD	9.5	22.5	6.5	2.0	4.0



Round-nose pliers 3522115 ESD



Round-nose pliers, flat, round jaws, gripping surface smooth.

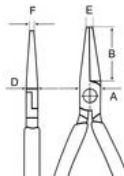

dpvlink 8835

Article	A [mm]	B [mm]	D [mm]	E [mm]	F [mm]
K-3522.115.ESD	9.5	22.5	6.5	2.0	1.5



Round-nose pliers 3532115 ESD



Round-nose pliers, round, pointed jaws, gripping surface smooth.

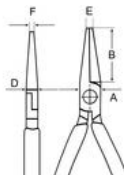

dpvlink 8836

Article	A [mm]	B [mm]	D [mm]	E [mm]	F [mm]
K-3532.115.ESD	9.5	22.5	6.5	2.0	1.0



Round-nose pliers 3542115 ESD



Round-nose pliers, semicircular jaws angled by 45°, gripping surfaces smooth.

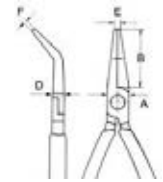

dpvlink 8837

Article	A [mm]	B [mm]	D [mm]	E [mm]	F [mm]
K-3542.115.ESD	9.5	22.5	6.5	2.0	1.5



End cutting pliers 6412115 ESD



End cutting pliers with bevel, angled 90°, small bevel

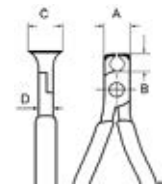

dpvlink 8838

Article	A [mm]	B [mm]	D [mm]	Cu wire [mm]
K-6412.115.ESD	11.0	6.0	7.0	1.4



Oblique end cutting pliers 6432120 ESD



Oblique end cutting pliers, angled by 15°, small bevel

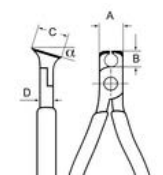

dpvlink 8839

Article	A [mm]	B [mm]	D [mm]	Cu wire [mm]
K-6432.120.ESD	11.0	10.0	7.0	1.5



Oblique end cutting pliers 6462120 ESD



Oblique end cutting pliers, small bevel, angled 65°.

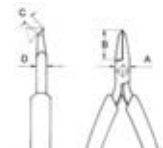

dpvlink 8840

Article	A [mm]	B [mm]	D [mm]	Cu wire [mm]
K-6462.120.ESD	11.0	20.0	7.0	0.6



Diagonal cutting pliers 7702115 ESD

Diagonal cutting pliers, round head, small bevel.

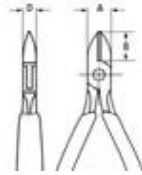

dpvlink 8841

Article	A [mm]	B [mm]	D [mm]	Cu wire [mm]
K-7702.115.ESD	11.0	14.0	7.5	0.3 -1.6



Diagonal cutting pliers 7712115 ESD

Diagonal cutting pliers, round head, large bevel and wire clamp.

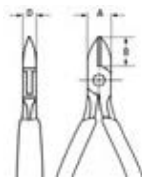

dpvlink 8842

Article	A [mm]	B [mm]	D [mm]	Cu wire [mm]
K-7712.115.ESD	11.0	14.0	7.5	0.3 -1.6



Diagonal cutting pliers 7722115 ESD

Diagonal cutting pliers, round head, without bevel.

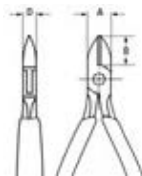

dpvlink 8843

Article	A [mm]	B [mm]	D [mm]	Cu wire [mm]
K-7722.115.ESD	11.0	14.0	7.5	0.3 -1.3



Diagonal cutting pliers 7732115 ESD

Diagonal cutting pliers, pointed head, small bevel.

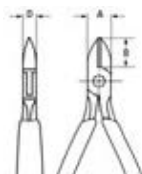

dpvlink 8844

Article	A [mm]	B [mm]	D [mm]	Cu wire [mm]
K-7732.115.ESD	11.0	14.0	7.5	0.3 -1.3



Diagonal cutting pliers 7742115 ESD

Diagonal cutting pliers, pointed head, without bevel.

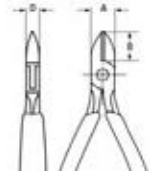

dpvlink 8845

Article	A [mm]	B [mm]	D [mm]	Cu wire [mm]
K-7742.115.ESD	11.0	14.0	7.5	0.3 -1.3



Diagonal cutting pliers 7752115 ESD

Diagonal cutting pliers, pointed, flat head, small bevel.

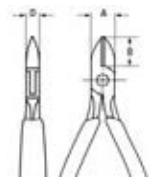

dpvlink 8846

Article	A [mm]	B [mm]	D [mm]	Cu wire [mm]
K-7752.115.ESD	11.5	14.0	7.5	0.3 -1.0



Diagonal cutting pliers 7772115 ESD

Diagonal cutting pliers, pointed mini head, small bevel.

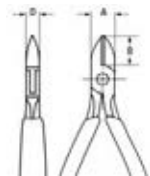

dpvlink 8847

Article	A [mm]	B [mm]	D [mm]	Cu wire [mm]
K-7772.115.ESD	9.5	10.5	6.5	0.3 -0.8



Diagonal cutting pliers 7702120H ESD

Diagonal cutting pliers with hard metal cutting edges, round head, large bevel

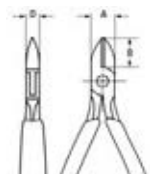

dpvlink 17325

Article	A [mm]	B [mm]	D [mm]	Cu wire [mm]
K-7702.120H.ESD	11.0	14.0	7.5	0.6 -2.0



Diagonal cutting pliers 7702135H ESD



Diagonal cutting pliers with hard metal cutting edges, round head, large bevel

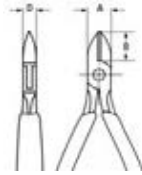

dpvlink 17326

Article	A [mm]	B [mm]	D [mm]	Cu wire [mm]
---------	--------	--------	--------	--------------

K-7702.135H.ESD	15.0	18.0	9.5	0.8 - 2.2
-----------------	------	------	-----	-----------



Diagonal cutting pliers 7732120H ESD



Diagonal cutting pliers with hard metal cutting edges, small bevel

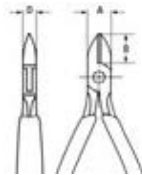

dpvlink 17327

Article	A [mm]	B [mm]	D [mm]	Cu wire [mm]
---------	--------	--------	--------	--------------

K-7732.120H.ESD	11.0	14.0	7.0	0.2 - 1.6
-----------------	------	------	-----	-----------



ESD Electronics pliers set



8 parts, contains 2 KNIPEX electronic pliers and 6 WERA screwdrivers, ESD version. Practical storage box, shock-resistant plastic, with foam insert.



Content consisting of:

Gripping pliers	K-3522.115.ESD
Diagonal cutting pliers	K-7702.115.ESD
Screwdriver	WE-1578A.80x2.5
Screwdriver	WE-1578A.80x3.0
Screwdriver	WE-1578A.80x3.5
Screwdriver	WE-1578A.80x4.0
Screwdriver	WE-1550ESD.PH0x60
Screwdriver	WE-1550ESD.PH1x80

dpvlink 18024

Article	Type
---------	------

K-0020.18.ESD	ESD Electronics plier set
---------------	---------------------------



ESD Electronics plier set



6-piece, equipped with 6 ESD electronics pliers. Case made of durable polyester fabric, pliers are held by elastic band, zipper.



Content consisting of:

Flat-nose pliers	K 3512.115.ESD
Round-nose pliers	K 3522.115.ESD
Round-nose pliers	K 3542.115.ESD
Oblique end cutting pliers	K 6432.115.ESD
Diagonal cutting pliers	K 7202.115.ESD
Diagonal cutting pliers	K 7732.125.ESD

dpvlink 8890

Article	Type
---------	------

K-0020.17.ESD	ESD Electronics plier set
---------------	---------------------------



Knipex "Profi" series

The Knipex "Profi" series for highest requirements concerning efficiency and performance. The precision cutting pliers have precision-ground, sharp cutting edges for the use e.g. in electronics and fine mechanics, with a small bevel or without bevel for precise cuts on sensitive electronic components. A low-friction double spring ensures a smooth and even opening. Forged of high-quality chrome-vanadium ball bearing steel with glare-free finish and low weight.

All versions are electrically dissipative

Flat-nose pliers 3412130 ESD



Flat-nose pliers with flat, wide jaws, smooth gripping surface for fine work.

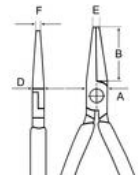

dpvlink 8827

Article	A [mm]	B [mm]	D [mm]	E [mm]	F [mm]
---------	--------	--------	--------	--------	--------

K-3412.130.ESD	11.2	21.9	6.5	1.4	3.5
----------------	------	------	-----	-----	-----



Flat-nose pliers 3442130 ESD



Flat-nose pliers with flat, wide jaws, precision laser cut cross-shaping, smooth gripping surface, for fine tasks.

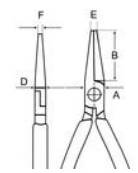

dpvlink 21479

Article	A [mm]	B [mm]	D [mm]	E [mm]	F [mm]
---------	--------	--------	--------	--------	--------

K-3442.130.ESD	11.2	22.7	6.5	1.6	1.6
----------------	------	------	-----	-----	-----



Round-nose pliers 3422130 ESD



Round-nose pliers with semicircular jaws, smooth gripping surface, for gripping fine parts and types of wires

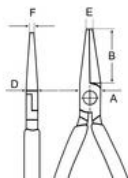

dpvlink 8828

Article	A [mm]	B [mm]	D [mm]	E [mm]	F [mm]
K-3422.130.ESD	11.2	22.7	6.5	1.6	1.6



Round-nose pliers 3452130 ESD



Round-nose pliers with semicircular jaws, precision laser cut cross-shaping, smooth gripping surface, for gripping fine components and forming wires

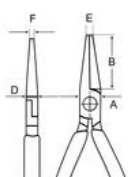

dpvlink 21481

Article	A [mm]	B [mm]	D [mm]	E [mm]	F [mm]
K-3452.130.ESD	11.2	22.7	6.5	1.6	1.6



Round-nose pliers 3432130 ESD



Round-nose pliers with round, pointed jaws, smooth gripping surface, for bending fine eyelets

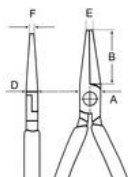

dpvlink 8829

Article	A [mm]	B [mm]	D [mm]	E [mm]	F [mm]
K-3432.130.ESD	11.2	22.7	6.5	1.6	1.6



Diagonal cutting pliers 7902120 ESD



Diagonal cutting pliers, round mini head with mini-bevel.

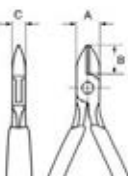

dpvlink 8821

Article	A [mm]	B [mm]	D [mm]	Cu wire [mm]
K-7902.120.ESD	9.0	6.5	6.5	0.2 - 1.0



Diagonal cutting pliers 7902125 ESD



Diagonal cutting pliers, round head with mini-bevel

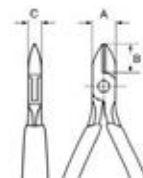

dpvlink 8822

Article	A [mm]	B [mm]	D [mm]	Cu wire [mm]
K-7902.125.ESD	11.0	10.0	6.5	0.2 - 1.5



Diagonal cutting pliers 7922120 ESD



Diagonal cutting pliers, round mini head without bevel

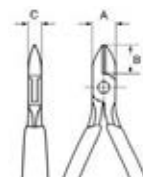

dpvlink 8824

Article	A [mm]	B [mm]	D [mm]	Cu wire [mm]
K-7922.120.ESD	9.0	6.5	6.5	0.1 - 0.8



Diagonal cutting pliers 7922125 ESD



Diagonal cutting pliers, round head without bevel.

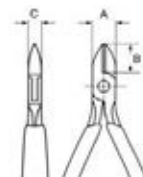

dpvlink 8823

Article	A [mm]	B [mm]	D [mm]	Cu wire [mm]
K-7922.125.ESD	11.0	10.0	6.5	0.1 - 1.2



Diagonal cutting pliers 7932125 ESD



Diagonal cutting pliers, pointed head with mini-bevel.

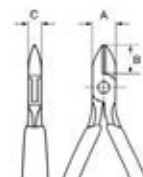

dpvlink 8825

Article	A [mm]	B [mm]	D [mm]	Cu wire [mm]
K-7932.125.ESD	11.0	11.0	6.5	0.2 - 1.5



Diagonal cutting pliers 7942125 ESD



Diagonal cutting pliers, pointed head without bevel.

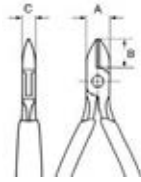

dpvlink 8826

Article	A [mm]	B [mm]	D [mm]	Cu wire [mm]
K-7942.125.ESD	11.0	11.0	6.5	0.1-1.5



Diagonal cutting pliers 7942125Z ESD



Diagonal cutting pliers, pointed head, for an optimized flush-mounted cutting result with soft materials, for mounting with tight tolerances, for precise wire end configuration

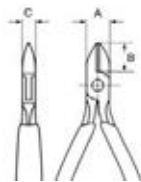

dpvlink 21477

Article	A [mm]	B [mm]	D [mm]	Cu wire [mm]
K-7942.125.Z.ESD	11.0	11.0	6.5	0.1-1.3



Diagonal cutting pliers 7952125 ESD



Diagonal cutting pliers, pointed head with mini-bevel and wire clamp ensuring that the cut wire ends are retained.

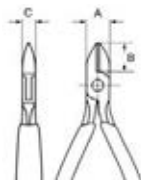

dpvlink 9527

Article	A [mm]	B [mm]	D [mm]	Cu wire [mm]
K-7952.125.ESD	11.0	11.0	6.5	0.4-1.3



Diagonal cutting pliers 7962125 ESD



Diagonal cutting pliers, pointed head without bevel with wire clamp ensuring that the cut wire ends are retained.

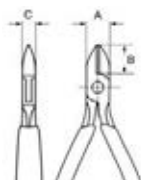

dpvlink 9528

Article	A [mm]	B [mm]	D [mm]	Cu wire [mm]
K-7962.125.ESD	11.0	11.0	6.5	0.55-1.0



ESD precision electronics pliers set



6-piece, containing 6 ESD precision electronics pliers. Case made of durable polyester fabric, pliers are held by elastic band, zipper.

Content consisting of:

Flat-nose pliers	K 3412.130.ESD
Round-nose pliers	K 3422.130.ESD
Round-nose pliers	K 3432.130.ESD
Diagonal cutting pliers	K 7902.120.ESD
Diagonal cutting pliers	K 7902.125.ESD
Diagonal cutting pliers	K 7942.125.ESD

dpvlink 8888

Article	Type
---------	------

K-0020.16P.ESD ESD precision electronics pliers set



Knipex VDE pliers

Knipex insulated tools are made of high-quality materials according to the regulations of national and international standards. In compliance with the prescribed safety measures for working under voltage, e.g. DIN VDE 0105, EN 50110, IEC 60364, they offer maximum protection when working under voltage up to AC 1000V (alternating current) and DC 1500V (direct current).

Knipex pliers with the two-colored multi-component handle insulation (red/yellow) meet the requirements of VDE 0682 part 201 and the corresponding international standards (e.g. EN 60900 or IEC 60900). The VDE / GS symbol shows that the requirement is confirmed by an inspecting authority committed to neutrality.

Combination pliers ISO 1000V



VDE-tested combination pliers made of chrome-vanadium electric steel, for toughest demands, particularly wear-resistant gripping jaws with gripping zones for flat and round material, cutting edges for soft, hard and piano wire, long cutting edges for thick cable

dpvlink 8894

Article	hard	Piano wire	L [mm]
K-0106.160	2,0 mm	1,5 mm	160
K-0106.190	2,5 mm	2,0 mm	190



Diagonal cutting pliers ISO 1000V

NEU



VDE-tested precision pliers for very fine cutting tasks, thin head shape with ultra-precise cut.

dpvlink 26477

Article	soft	medium	L [mm]
K-7806.125	0.2-1.6 mm	1,0 mm	125 mm



Cable shears 1000V

NEU



VDE-tested cable shears, hardened cutting edges with precision grinding, cuts smoothly and cleanly without squeezing. The innovative graded edges cut wires one after another for less effort.

dpvlink 26479

Article	Capacity	L [mm]
K-9516.160	50 mm ²	160 mm



High-leverage combination pliers ISO 1000V



VDE-tested high-leverage combination pliers made of special tool steel, for toughest demands, 35% power saving by new improved leverage. Particularly wear-resistant gripping jaws with gripping zones for flat and round material, cutting edges for soft, hard and piano wire, long cutting edges for thick cables.

dpvlink 8897

Article	hard	Piano wire	L [mm]
K-0206.180	2.5 mm	2.0 mm	180
K-0206.200	2.8 mm	2.2 mm	200
K-0206.225	3.0	2.5 mm	225



Combination pliers ISO 1000V



VDE-tested high-leverage combination pliers made of special tool steel, for toughest demands, gripping jaws with gripping zones for flat and round materials, cutting edges for soft, hard and piano wire, long cutting edges for thick cables.

dpvlink 8901

Article	hard	medium	L [mm]
K-0306.160	2,0 mm	3,1 mm	160
K-0306.180	2,2 mm	3,4 mm	180
K-0306.200	2,5 mm	3,8 mm	200



Flat-nose pliers ISO 1000V

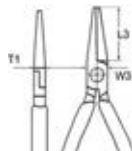

VDE-tested flat-nose pliers with short, flat jaws and serrated gripping surfaces made of special tool steel.

dpvlink 8957

Article	L3	W3	T1	L [mm]
K-2006.160	30.0 mm	17.0 mm	9.5 mm	160



Round-nose pliers ISO 1000V

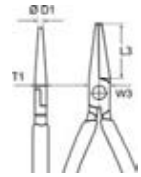

VDE-tested round-nose pliers for the bending of wire eyelets. With short, round and precision-ground jaws, smooth tips, made of special tool steel.

dpvlink 8959

Article	L3	W3	Ø D1	L [mm]
K-2206.160	30.0 mm	18.0 mm	3.0 mm	160



Taper-nose pliers with cutting edges ISO 1000V

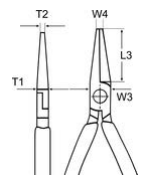

VDE-tested flat-nose pliers with cutting edges, suitable for cutting work in the fine mechanics. Pointed, semicircular jaws with serrated gripping surfaces made of special tool steel in special quality. Cutting for medium-hard and hard wire.

dpvlink 8961

Article	L3	W3	T1	W4	T2	L [mm]
K-2506.160	50.0 mm	16.5 mm	9.5 mm	3.0 mm	2.5 mm	160



Taper-nose pliers 40° with cutting edges ISO 1000V

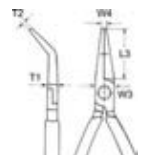

VDE-tested flat-nose pliers with cutting edges, bent by 40°, suitable for cutting work in the fine mechanics. Pointed, flat and round jaws with serrated gripping surfaces made of special tool steel in special quality. Cutting edges for medium-hard and hard wire.

dpvlink 8963

Article	L3	W3	T1	W4	T2	L [mm]
K-2526.160	50.0 mm	16.5 mm	9.5 mm	3.0 mm	2.5 mm	160



Taper-nose pliers with cutting edges ISO 1000V

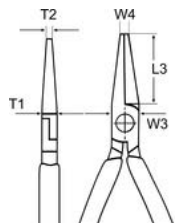

VDE-tested flat-nose pliers with cutting edges, highly-resistant, elastic precision tips, flat round jaws with serrated gripping surfaces made of vanadium steel. Cutting edges for medium-hard and hard wire.

dpvlink 8965

Article	L3	W3	T1	W4	T2	L [mm]
K-2616.200	73.0 mm	17.5 mm	2.5 mm	3.0 mm	9.5 mm	200



Long-nosed pliers ISO 1000V



VDE-tested long-nosed pliers, highly-resistant and low-wear. Long, flat jaws with serrated gripping surfaces, made of chrome-vanadium electric steel.

dpvlink 8969

Article	L3	W3	T1	W4	T2	L [mm]
K-3016.160	46.6 mm	16.5 mm	9.5 mm	3.0 mm	5.0 mm	160



Long-nosed pliers ISO 1000V



VDE-tested long-nosed pliers, highly-resistant and low-wear. Long, round jaws with smooth polished gripping surfaces made of chrome-vanadium electric steel.

dpvlink 8971

Article	L3	W3	T1	W4	T2	L [mm]
K-3036.160	41.0 mm	16.5 mm	9.5 mm	5.0 mm	2.5 mm	160



Diagonal cutting pliers ISO 1000V



VDE-tested versatile diagonal cutting pliers, slim head shape with precision cutting edges for a clean cut on soft and hard wire. Precisely processed, made of high-quality vanadium electric steel.

dpvlink 8905

Article	soft	medium	hard	L [mm]
K-7006.125	3.0 mm	2.3 mm	1.5 mm	125
K-7006.140	4.0 mm	2.8 mm	1.8 mm	140
K-7006.160	4.0 mm	3.0 mm	2.0 mm	160
K-7006.180	4.0 mm	3.0 mm	2.5 mm	180
K-7026.160	4.0 mm	-	-	160



High-leverage diagonal cutting pliers ISO 1000V



VDE-tested high-leverage diagonal cutting pliers with forged joint axis, for toughest, durable demands. Induction-hardened precision cutting edges offering a high cutting performance with minimum effort. Optimal for all wires. Made of chrome-vanadium electric steel.

dpvlink 8911

Article	medium	hard	Piano wire	L [mm]
K-7406.160	3.4 mm	2.7 mm	2.2 mm	160
K-7406.180	3.8 mm	2.7 mm	2.0 mm	180
K-7406.200	4.2 mm	3.0 mm	2.5 mm	200
K-7406.250	4.6 mm	3.5 mm	3.0 mm	250



Cable shears ISO 1000V



VDE-tested cable shears, hardened cutting edges with precision grinding, cuts smoothly and cleanly without squeezing. Easy cutting with one-hand operation, trap protection, adjustable screw joint, self-locking.

dpvlink 9009

Article	Capacity	L [mm]
K-9516.165	50 mm ²	165



Cable shears ISO 1000V



VDE-tested cable shears, hardened cutting edges with precision grinding, cuts smoothly and cleanly without squeezing. Minimum effort by favorable lever ratio, easy cutting by one-hand operation, trap protection, adjustable screw joint, self-locking.

dpvlink 9011

Article	Capacity	L [mm]
K-9516.200	70 mm ²	200



Cable cutter ISO 1000V



VDE-tested cable shears, hardened cutting edges with precision grinding, cuts smoothly and cleanly without squeezing. Two-stage ratchet drive for easy cutting. Minimum effort by favorable lever ratio, trap protection, adjustable screw joint, self-locking.

dpvlink 9013

Article	Diameter	Capacity	AWG	L [mm]
K-9536.250	32 mm	240 mm ²	500	250
K-9536.280	52 mm	380 mm ²	750	280



Compact box ISO 1000V



4-piece, contains 4 VDE-tested pliers. High-quality and versatile, impact-resistant plastic suitcase, napped foam insert for variable equipment. (Dimensions WxDxH: 327x275x65 mm)

Consisting of:

Combination pliers	K-0306.180
Stripping pliers	K-1106.160
Taper-nose pliers	K-2616.200
Diagonal cutting pliers	K-7006.160

dpvlink 8892

Article	Type
K-002015	Compact box ISO 1000V



Lindstrom



The RX series by Lindstrom impresses by its high performance, precision and comfort. The material consisting of 1% carbon / chrome steel (ball bearing quality) is made for extremely high demands regarding stability and resistance. By the precision induction-hardening, a Rockwell hardness of 63-65 HRC was achieved. The precision joint with nut and bolt guarantees the perfect alignment of the cutting edges and a long service life.



Handles: comfortable for large and small hands. Softly rounded shapes ensure the easy handling for precision work. Spring tension and opening width are easily adjustable. Longer and wider levers distribute the pressure and prevent joint loads.



With small bevel (facet)

Normal cut. Suitable for cutting hard and soft steel wires as well as soft materials such as copper wire and cable.



With large bevel (facet)

Suitable for cutting hard and very hard steel wires. Long service life.



Without bevel flush (facet)

Flush cut for soft materials.

Diagonal cutting pliers



Diagonal cutting pliers with oval jaws; depending on version with small bevel, large bevel or flush without bevel



dpvlink 9627

Article	C [mm]	B [mm]	D [mm]	F [mm]	Cu wire [mm]
RX8130	8.0	8.5	5.0	0.8	0.2 - 1.0
RX8131	8.0	8.5	5.0	0.8	0.1 - 1.0
RX8132	8.0	8.5	5.0	0.8	0.1 - 0.8
RX8140	10.0	10.5	6.0	0.8	0.2 - 1.25
RX8141	10.0	10.5	6.0	0.8	0.1 - 1.25
RX8142	10.0	10.5	6.0	0.8	0.1 - 1.0
RX8150	12.5	13.0	6.0	1.2	0.3 - 1.6
RX8151	12.5	13.0	6.0	1.2	0.2 - 1.6
RX8152	12.5	13.0	6.0	1.2	0.2 - 1.25
RX8160	16.0	16.0	8.0	1.6	0.4 - 2.0
RX8161	16	16.0	8.0	1.6	0.3 - 2.0
RX8162	16	16.0	8.0	1.6	0.3 - 1.6

Diagonal cutting pliers



Diagonal cutting pliers with pointed jaws; depending on version with small bevel, large bevel or flush without bevel

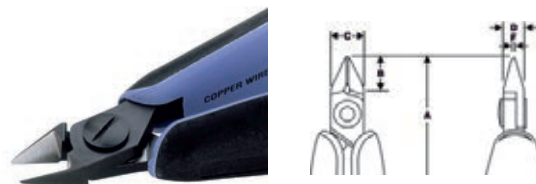

dpvlink 9640

Article	C [mm]	B [mm]	D [mm]	F [mm]	Cu wire [mm]
RX8143	10.0	10.5	6.0	0.8	0.2 - 1.25
RX8144	10.0	10.5	6.0	0.8	0.1 - 1.25
RX8145	10.0	10.5	6.0	0.8	0.1 - 1.0

Diagonal cutting pliers



Diagonal cutting pliers with pointed, tapered jaws; depending on version with small bevel, large bevel or flush without bevel



dpvlink 9644

Article	C [mm]	B [mm]	D [mm]	F [mm]	Cu wire [mm]
RX8146	10.0	10.5	6.0	0.8	0.1 - 1.0
RX8147	10.0	10.5	6.0	0.8	0.1 - 0.8
RX8148	10.0	10.5	6.0	0.8	0.1 - 0.8

End cutting pliers



End cutting pliers with small bevel

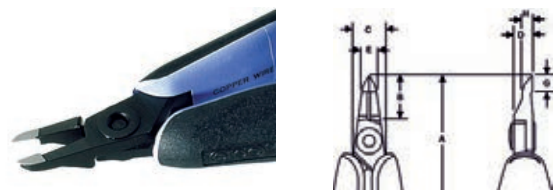

dpvlink 9648

Article	C [mm]	B [mm]	D [mm]	F [mm]	Cu wire [mm]
RX8149	10.0	14.0	6.0	5.0	0.1 - 0.6

Precision tools

Oblique end cutting pliers, 20° bent



Oblique end cutting pliers, bent by 20°; with short jaws and small bevel

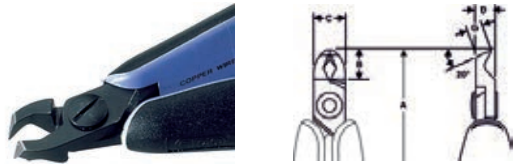

dpvlink 9654



Article	C [mm]	B [mm]	D [mm]	F [mm]	Cu wire [mm]
RX8211	10.0	9.5	6.0	4.1	0.2-1.2



Oblique end cutting pliers, 45° bent



Oblique end cutting pliers with long jaws, bent by 45°, with small bevel

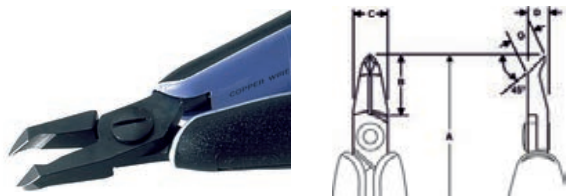

dpvlink 9658



Article	C [mm]	B [mm]	D [mm]	F [mm]	Cu wire [mm]
RX8247	10.0	18.0	6.0	6.7	0.2-1.0



Oblique end cutting pliers, 45° bent



Oblique end cutting pliers with long, tapered jaws, bent by 45°, with small bevel

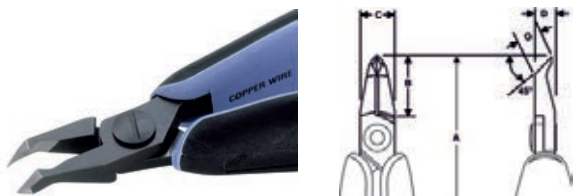

dpvlink 9660



Article	C [mm]	B [mm]	D [mm]	F [mm]	Cu wire [mm]
RX8248	10.0	18.0	6.0	6.7	0.2-0.8



Micro diagonal cutting pliers, 50°



Micro diagonal cutting pliers with long jaws, bent by 50°, small bevel



dpvlink 9656



Article	C [mm]	B [mm]	D [mm]	F [mm]	Cu wire [mm]
RX8237	10.6	17.4	7.0	4.1	0.1-0.65



Flat-nose pliers

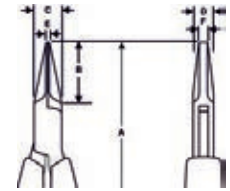

dpvlink 9662



Article	C [mm]	B [mm]	D [mm]	E [mm]	F [mm]
RX7490	9.0	20	6.7	1.2	3.2

Round-nose pliers

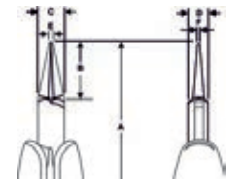

dpvlink 9664



Article	C [mm]	B [mm]	D [mm]	E [mm]	F [mm]
RX7590	9.0	20.0	6.7	1.8	0.9

Long-nosed pliers



Long-nosed pliers with long jaws

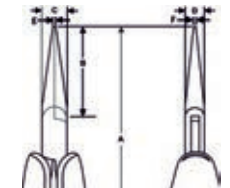

dpvlink 9666



Article	C [mm]	B [mm]	D [mm]	E [mm]	F [mm]
RX7890	9.0	32.0	6.0	1.2	0.8
RX7891	9.0	32.0	6.0	1.2	0.8

-Version RX7891 with cut-

Long-nosed pliers, 60° bent



dpvlink 9668



Article	C [mm]	B [mm]	D [mm]	E [mm]	F [mm]
RX7892	9.0	29.0	6.7	1.2	0.8

Long-nosed pliers



Long-nosed pliers with short jaws

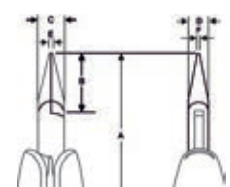

dpvlink 9670



Article	C [mm]	B [mm]	D [mm]	E [mm]	F [mm]
RX7893	9.0	20.0	6.7	1.2	0.8

Erem Precision tools



High-precision joints
The double self-locking screw joint with an extremely large movement area minimizes wear and tear.



Patented opening system
For the invisible integration of the springs. The result has proved: no risk of injury, long-lasting, exchangeable.



Antistatic standard handles
Contact resistance between 10^6 and 10^9 ohm according to MIL standards.



Stop! Stop system
Avoids the crossing (and thus the damaging) of the cutting edges.



Wire holder (option)
Prevents injuries of the eyes and the destruction of devices by uncontrollably separated cutting waste.

The cutting shapes and cutting performance:



With small bevel (facet)
Normal cut. Suitable for cutting hard and soft steel wires as well as soft materials such as copper wire and cable.



With large bevel (facet)
Suitable for cutting hard and very hard steel wires. Long service life.



Without bevel (facet)
Flush cut. Extremely sharp cutting edges. Only suitable for soft steel wires, copper wire and cable.



Without bevel flush (facet)
Flush cut for soft materials.

Erem 500 / 600 series

Diagonal cutting pliers Micro 612N / 622N / 632N Erem



dpvlink 2397

Article	L [mm]	A [mm]	Max Cu
612N small bevel	110	9.0	1.3 mm
622N large bevel	110	9.0	1.3 mm
632N flush cut	110	10.0	1.3 mm

Diagonal cutting pliers Micro 622NA Erem



dpvlink 9962

Article	L [mm]	A [mm]	Max Cu
622NA large bevel	110	9.0	1.0 mm

Diagonal cutting pliers Micro 622NB Erem



dpvlink 2404

Article	L [mm]	A [mm]	Max Cu
622NB large bevel	110	9.0	0.8 mm

Diagonal cutting pliers 512E Erem



Non-reflecting. The typical general purpose diagonal cutting pliers for robust applications.



dpvlink 2399

Article	L [mm]	A [mm]	Max Cu
512E small bevel	115	12.0	1.6 mm

Universal diagonal cutting pliers 512N / 522N / 532N **Erem**



dpvlink 2401

Article		L [mm]	A [mm]	Max Cu
 512N	small bevel	115	12.0	1.6 mm
 522N	large bevel	115	12.0	1.6 mm
 532N	flush cut	115	12.0	1.6 mm



Tip cutting pliers 570E **Erem**



To cut at the extreme tip.

dpvlink 2417

Article		L [mm]	A [mm]	C [mm]	Max Cu
 570E	large bevel	120	22.0	6.0	0.6 mm



Tip cutting pliers 573E **Erem**



For fine wires

dpvlink 9965

Article		L [mm]	A [mm]	Max Cu
 573E	large bevel	125	11.0	0.8 mm



Tip cutting pliers angled 45° 582E **Erem**

Ideal for working on printed circuit boards.

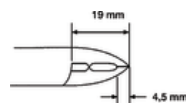
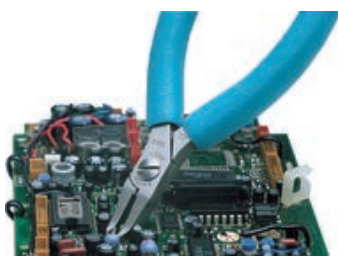

dpvlink 2414

Article		L [mm]	A [mm]	C [mm]	Max Cu
 582E	large bevel	115	10.0	6.0	1.3 mm



Tip cutting pliers, angled **Erem**



With a wide, but sturdy head for universal cutting tasks

dpvlink 9967

Article		L [mm]	A [mm]	Max Cu
 503E	large bevel	115	10.5	1.6 mm



DIL contact cutting pliers 30° 593AE **Erem**



For the use on tightly equipped printed circuit boards. Useful maintenance tool.

dpvlink 2807

Article	A [mm]	C [mm]
 593AE	20.0	6.0



Erem "2400 MagicSense" series



The ESD safe series 2400 MagicSense combines high-quality processing, precision and cutting comfort. The ergonomically shaped MagicSense handles prevent fatigue of the hand. The cutting edges are produced by using a special hardening process and can be re-sharpened ensuring a high service life.

Diagonal cutting pliers 2412E **Erem**



Diagonal cutting pliers, oval and sturdy head for universal use, high cutting capacity, for soft and thin wires.

dpvlink 8725

Article	L [mm]	A [mm]	B [mm]	C [mm]	Max Cu
 2412E	130	12.0	11.0	6.0	1.6 mm



Diagonal cutting pliers 2422E **Erem**

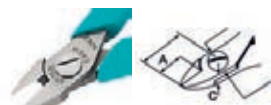

Diagonal cutting pliers, with oval and robust head for universal use. For soft and thin wires of medium thickness.

dpvlink 8727

Article	L [mm]	A [mm]	B [mm]	C [mm]	Max Cu
 2422E	130	12.0	11.0	6.0	1.6 mm



Diagonal cutting pliers 2432E

Erem



Diagonal cutting pliers, narrow, oval head. Perfect flush cut, with razor-sharp cut. Only for soft wires.

dpvlink 8729

Article	L [mm]	A [mm]	B [mm]	C [mm]	Max Cu
2432E	130	12.0	11.0	6.0	1.6 mm



Diagonal cutting pliers beveled 2477E

Erem



Diagonal cutting pliers, beveled, pointed head, for working on narrow, difficult to reach areas.

dpvlink 8731

Article	L [mm]	A [mm]	B [mm]	C [mm]	Max Cu
2477E	127	12.0	11.0	6.0	1.3 mm



Tip cutting pliers 2470E

Erem



Tip cutting pliers, straight, beveled head. For horizontal cutting and easier access to narrow places. Only for thin wires, cuts at the extreme tip.

dpvlink 8733

Article	L [mm]	A [mm]	B [mm]	C [mm]	Max Cu
2470E	140	20.0	11.0	6.0	0.6 mm



Tip cutting pliers 30° angled 2403E

Erem



Tip cutting pliers angled by 30°, wide and robust head, fine cut, for universal cutting tasks.

dpvlink 8735

Article	L [mm]	A [mm]	B [mm]	C [mm]	Max Cu
2403E	127	9.0	11.0	6.0	1.6 mm



Tip cutting pliers 30° angled 2404E

Erem



Tip cutting pliers angled by 30°; fine, rounded head. Fine cut for universal cutting tasks.

dpvlink 8737

Article	L [mm]	A [mm]	B [mm]	C [mm]	Max Cu
2404E	127	9.3	11.0	6.0	1.3 mm



Tip cutting pliers 45° angled 2482E

Erem



Tip cutting pliers angled by 45°, medium size, suitable for working on printed circuit boards or for cutting DIL component etc, can be used at 90° as well as at 180°.

dpvlink 8739

Article	L [mm]	A [mm]	B [mm]	C [mm]	Max Cu
2482E	135	15.0	11.0	6.0	1.0 mm



Tip cutting pliers 45° angled 2475E

Erem



Tip cutting pliers angled by 45°, narrow head. For fine work on hybrid circuits or micro components, as well as narrow, difficult to reach places.

dpvlink 8741

Article	L [mm]	A [mm]	B [mm]	C [mm]	Max Cu
2475E	135	13.0	11.0	6.0	0.6 mm



Diagonal cutting pliers beveled 2476TX1

Erem



High-precision diagonal cutting pliers, beveled head. Tungsten-carbide cutting edges, narrow head for working on narrow places, e.g. stainless wires, catheters and spirals.

dpvlink 8743

Article	L [mm]	A [mm]	B [mm]	C [mm]	Max Cu
2476TX1	128	10.0	11.0	6.0	1.0 mm



Needle-nose pliers 2411P

Erem



Needle-nose pliers with very precise, finely rounded jaws.

dpvlink 8745

Article	L [mm]	A [mm]	B [mm]	C [mm]	G [mm]
2411P	150	33.2	11.0	6.0	1.2



Needle-nose pliers 2411PD

Erem



Needle-nose pliers, inside serrated, very precise, finely rounded jaws.

dpvlink 8747

Article	L [mm]	A [mm]	B [mm]	C [mm]	G [mm]
2411PD	150	33.2	11.0	6.0	1.2



Flat-nose pliers 2442P

Erem



Flat-nose pliers with fine jaws, precisely crafted edges e.g. for gripping flat workpieces.

dpvlink 8749

Article	L [mm]	A [mm]	B [mm]	C [mm]	G [mm]
2442P	146	33.2	11.0	6.0	1.2



Round-nose pliers 2443P



Round-nose pliers with very precise, fine jaws for bending wires.

dpvlink 8750

Article	L [mm]	A [mm]	B [mm]	C [mm]
2443P	146	30.5	11.0	6.0



Erem 2400 MagicSense



Consisting of:

- 2412E diagonal cutting pliers series 2400 MagicSense with bevel, oval head
- 2482E tip cutting pliers series 2400 MagicSense, with small bevel, narrow head
- 2411P needle-nose pliers series 2400 MagicSense

dpvlink 10766

Article	Ausführung
2400KMS	Erem 2400 MagicSense



Erem Toolset universal



Consisting of:

- XP600 precision screwdriver set for electronics
- 2412E diagonal cutting pliers of series 2400 MagicSense with bevel, oval head
- 2442P flat-nose pliers of series 2400 MagicSense
- 622NB tip cutting pliers, with large bevel, relieved, long, fine head
- AASA precision tweezers
- 2ASASL precision tweezers

dpvlink 10764

Article	Ausführung
3600KU	Erem Toolset universal



Erem 700 series

fo a perfect flush cut

Diagonal cutting pliers 792E



With fine, long tips (13 mm). For fine copper wires

dpvlink 2430

Article	L [mm]	A [mm]	Max Cu	D [mm]
792E	115	12.0	0.6 mm	19.0



Erem SMD tools

Tip cutting pliers 670EP

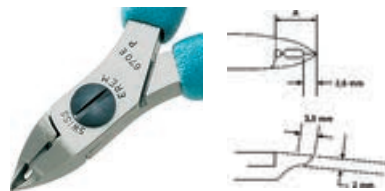

High-precision tip cutting pliers for SMD and micro case contacts up to 0.25 mm, also for grid smaller 1/20", application e.g. as a replacement for hot air or de-soldering systems that damage the printed circuit board very often.

dpvlink 2432

Article	L [mm]	A [mm]
670EP	110	10.0



Erem Forming tools

Forming tool 500-103A



Forming pliers for bending flat parts, contacts, power transistors, TRIAC connections, etc. at right angle.

dpvlink 2471

Article	L [mm]	B [mm]
500-103A	120	15



Forming tool 500-104A



Bends components T0126, 218, 220 power transistors, etc. by 90° on two rows. Adjustable with screw.

dpvlink 2481

Article	L [mm]	B [mm]
500-104A	120	13.0



Forming tool



Forming pliers for component connections etc. in U-shape by axial forming.



dpvlink 2459

Article	L [mm]	A [mm]
554A	120	23.0



Erem Special pliers

Precision stripping pliers



Adjustable, for front stripping 0.25 - 1.02 mm (AWG 18 - 30).



dpvlink 2504

Article	L [mm]	A [mm]
510AE	120	27.0



Bending pliers



Inside serrated.



dpvlink 2509

Article	L [mm]	A [mm]	C [mm]
544D	120	23	6.0



Diagonal cutting pliers 884E



Relieved head for working on narrow places. Flush cut, small bevel.



dpvlink 2519

Article	L [mm]	A [mm]	D [mm]	Max Cu
884E	120	15.0	21.0	1.6 mm



Diagonal cutting pliers 884EPC

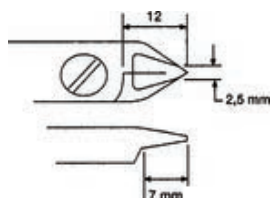

Simple diagonal cutting pliers for separating PCBs.

dpvlink 2536

Article	L [mm]
884EPCM	115



Diagonal cutting pliers 886E

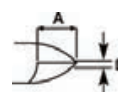

Relieved head for working on narrow places. Robust head. Flush cut, small bevel.



dpvlink 2541

Article	L [mm]	A [mm]	D [mm]	Max Cu
886E	120	15.0	21.0	1.8 mm



Distance cutting pliers



With fixed cutting length



dpvlink 9969

Article	L [mm]	A [mm]	Max Cu	Bevel
530E06	120	20.0	1.2 mm	large bevel
530E08	120	20.0	1.2 mm	large bevel
530E10	120	20.0	1.2 mm	large bevel
530E12	120	20.0	1.2 mm	large bevel
530E13	120	20.0	1.2 mm	large bevel
530E15	120	20.0	1.2 mm	large bevel



Distance cutting pliers



With fixed cutting length



dpvlink 9974

Article	L [mm]	A [mm]	Max Cu	Bevel
549E	120	20.0	1.2 mm	large bevel
549E10	120	20.0	1.2 mm	large bevel
549E12	120	20.0	1.2 mm	large bevel



Distance cutting pliers 530E15A



With variable cutting length



dpvlink 9978

Article	L [mm]	A [mm]	Max Cu	Bevel
530E15A	125	11.0	1.2 mm	large bevel



Stripping / crimping

Stripping tools Piergiacomini



Stripping tool SF-30.D



Patented, adjustable cable stripping pliers. Strips without damaging the wires. Length 141 mm, CU Ø 0.20-0.64 mm, 32-22 AWG



dpvlink 2285

Article Type

SF-30.D **Stripping tool SF-30.D**



Stripping tool SFF-30.D



Not adjustable cable stripping pliers. On request available with other dimensions. Length 141 mm, CU Ø 0.32-0.51 mm, 28-24 AWG

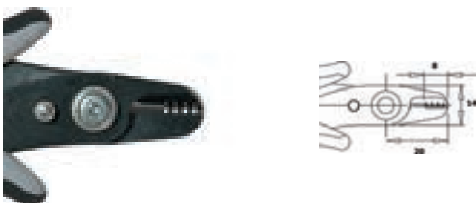

dpvlink 2291

Article Type

SFF-30.D **Stripping tool SFF-30.D**



Stripping tool CSF 30.D



Cable stripping shears. Excellent cutting properties with a groove for stripping. Length 144 mm, CU Ø 0.40-1.30 mm, 26-16 AWG

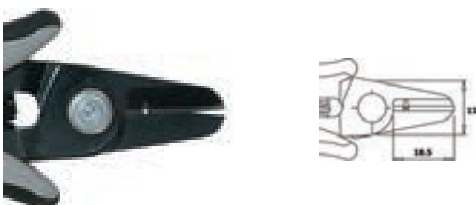

dpvlink 2293

Article Type

CSF-30.D **Stripping tool CSF 30.D**



Stripping tool CSP-30.1.D



Multi-purpose tool, resistant. Offers three different functions: SHEARS, CABLE STRIPPER, PLIERS. Length 165 mm, CU Ø 0.25-0.81 mm, 30-20 AWG

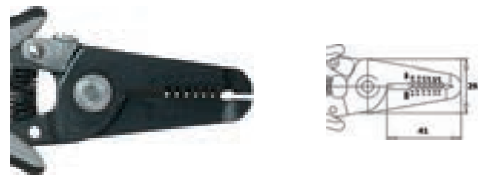

dpvlink 2298

Article Type

CSP-30.1.D **Stripping tool CSP 30.1.D**



Stripping tool CSP.30.2.D



Multi-purpose tool, resistant. Offers three different functions: SHEARS, CABLE STRIPPER, PLIERS. Length 165 mm, CU Ø 0.81-2.59 mm, 20-10 AWG



dpvlink 2300

Article Type

CSP-30.2.D **Stripping tool CSP.30.2.D**



Cable tie cutting pliers CSP.30.4.D



Cable tie cutting pliers with clean cut for the removing of synthetic tapes/cable ties. Length 160 mm, max. Cu-Ø 10 mm, 000 AWG



dpvlink 22003

Article Type

CSP-30.4.D **Stripping tool CSP.30.4.D**



Stripping / crimping tools CK

Multifunctional stripper



for the stripping, cutting and crimping of wires; hardened steel blades for a long service life; automatic stripping of wires without adjustment; crimping of insulated and uninsulated terminal clamp; micro adjusting knob allows the stripping of wires of less 0.2 mm².

Capacities:

- Stripping: 0.2 - 6.0 mm² (copper or aluminium wire)
- Cutting: Wire with HRC 40-50
- Crimping: 1.2; 2.5; 6.0 mm insulated terminal clamps and 1.5; 2.5; 4.0 and 6.0 mm uninsulated terminal clamps, as well as uninsulated ring terminal

dpvlink 10607

Article	Type
495001	Multifunctional stripper



Crimping pliers for wire end ferrules

Ratchet crimping pliers made of high-quality steel alloy with comfortable handles for crimping wire end ferrules; with blocking system and ground pressing jaws for a long and accurate crimping. Guarantees up to 30.000 crimp connections. With quick release lever, pressure setting, tested for a 100% correct dimensioning.



dpvlink 10565

Article	L [mm]	Capacity	AWG
430018	190	0.14 - 2.5 mm ²	26 - 14
430029	190	0.25 - 6.0 mm ²	20 - 10
430022	230	10.0 - 25.0 mm ²	8 - 3



Crimping pliers for terminal clamps

Ratchet crimping pliers for insulated terminal clamps; color-coded for terminal clamps (red, blue and yellow); for cross-section 0.5-6 mm² / 20-10 AWG; pliers made of high-quality steel alloy with comfortable handles; with blocking system and ground jaws for a long and precise crimping. Guarantees up to 30,000 crimp connections; with quick release lever, with pressure setting. Tested for a 100% correct dimensioning; length: 220 mm



dpvlink 10563

Article	L [mm]	Capacity	AWG
430021	220	0.5 - 6.0 mm ²	20 - 10



ESD Precision stripping tool, adjustable



Adjustable ESD Precision stripping tool, made of dissipative material; adjustable to each 6 cable diameter; suitable for PVC, Teflon and other material; 50 mm scale with 1 mm division and adjustable length stop; specially hardened blades

dpvlink 19323

Article	Max Cu
3757ESD-1	0.12 - 0.40 mm
3757ESD-2	0.25 - 0.80 mm
3757ESD-3	0.30 - 1.0 mm



ESD stripping pliers Ecotronic



ESD stripping pliers Ecotronic

For a safe and non-damaging stripping of fine, insulated solid wire in applications during which damage caused by electrostatical charge must be avoided at all costs. Six preset blade pares for the stripping of the envelope of insulated, solid core wires.



dpvlink 21294

Article	AWG	Max Cu	L [mm]
3893.ESD	20 - 30	0.2 - 0.8 mm	168
3894.ESD	16 - 26	0.4 - 1.3 mm	168
3895.ESD	10 - 20	0.8 - 2.6 mm	168



Stripping tools Knipex

Stripping pliers ISO 1000V



For single-, multi- and fine-wired conductors insulated with plastic / rubber, easy adjustment by knurled nut and lock nut, opening spring, special tool steel.

dpvlink 8938

Article	L [mm]	Diameter	Capacity	AWG
K-1106.160	160	5.0 mm	10.0 mm ²	7



Stripping diagonal cutting pliers ISO 1000V



Insulated, VDE-certified stripping cutting pliers, with precision stripping holes for single wire (massive) conductors. Induction-hardened precision cutting edges for soft wire (Ø up to 4.0 mm). Cutting hardness approx. 60 HRC, made of vanadium electric steel.

dpvlink 8955

Article	L [mm]	Capacity	AWG
K-1426.160	160	1.5 - 2.5 mm ²	15 - 13



Automatic stripping pliers



Gentle stripping of fine wires, clamping jaws hold the wire while stripping. Length stop for constant stripping lengths in serial work. Pressure spring to reach the starting position, robust light metal body.

dpvlink 8940

Article	L [mm]	Diameter	Capacity	AWG
K-1211.180	180	0.5 - 2.0 mm		
K-1221.180	180		0.5 - 6.0 mm ²	20 - 9



Universal stripping pliers



Easy stripping of difficult-to-process insulating materials such as Teflon®, silicone, RADOX®, Kapton® and rubber as well as multi-layer insulation. No damaging of conductors by precisely ground forming blades. Gentle stripping of fine wires; length stop, smooth-running mechanism, high ease of use due to the handy, compact design; 4 exchangeable blades.

dpvlink 8943

Article	L [mm]	Capacity	AWG
K-121202.195	195	0.03 - 2.08 mm ²	32 - 14
K-121206.195	195	0.14 - 6.0 mm ²	26 - 10
K-121210.195	195	2.5 - 10.0 mm ²	13 - 7



Stripping pliers, self-adjusting



For single, multi- and fine-wired conductors insulated with plastic/rubber. Automatically adjusting to conductor cross-section. Cutting depth readjustable. Smooth-running mechanism, easily exchangeable blades and plastic clamping jaws with wire cutters (multi-wired up to 10 mm², single-wired up to 6 mm²), low weight, case made of tough, glass fiber reinforced plastic.

dpvlink 8947

Article	L [mm]	Capacity	AWG	Length stop
K-1240.200	200	0.03 - 10.0 mm ²	32 - 7	3.0 - 18.0 mm



Stripping pliers, self-adjusting



Fully automatic adjustment to the different insulation thicknesses depending on the cross-section; automatic setting of the cutting depth; clamping jaws made of steel with integrated cutting edges, with wire cutters (multi-wired up to 10 mm², single-wired up to 6 mm²); tough, glass fiber reinforced plastic case.

dpvlink 8951

Article	L [mm]	Capacity	AWG
K-1242.195	195	0.03 - 10.0 mm ²	32 - 7



Stripping pliers, self-adjusting



Compact standard tool with slim head shape; for single-, multi- and fine-wired conductors; automatic adjustment to the conductor cross-section; high ease of use due to the handy and light design; length stop, wire cutters up to 2.5 mm², easily exchangeable blades, case made of tough, glass fiber reinforced plastic; with ergonomic soft plastic zone in the handles.

dpvlink 8953

Article	L [mm]	Capacity	AWG
K-1262.180	180	0.2 - 6.0 mm ²	24 - 10



Crimping tools Knipex

High-quality crimping pliers by Knipex for the professional crimping of wire end ferrules, plugs and cable connectors.

Wire end ferrule pliers



Wire end ferrule pliers for the crimping of wire end ferrules according to DIN 46228 parts 1 + 4, crimping in marked trapeze profiles for a safe connection of sleeve and conductor, vanadium steel.

dpvlink 8998

Article	L [mm]	Capacity	AWG
K-9762.145A	145	0.25 - 2.5 mm ²	23 - 13



Wire end ferrule pliers



Wire end ferrule pliers for the crimping of wire end ferrules according to DIN 46228 parts 1 + 4, especially suitable for the working on difficult to reach places, e.g. in narrow and deep electrical cabinets, special tool steel.

dpvlink 9000

Article	L [mm]	Capacity	AWG
K-9772.180	180	0.25 - 16.0 mm ²	23 - 5



Self-adjusting crimping pliers with square crimp



Crimping pliers with square crimp for the crimping of wire end ferrules. For standard, solderless, electrical connections, lateral insertion of the wire end ferrules, easy handling by self-adjustment, high ease of use, low weight, constantly high crimping quality by restraint lock (unlockable); crimping pressure factory-set; reinforcement by leverage.



dpwlink 8991

Article	L [mm]	Capacity	AWG
K-975304.180	180	0.08 - 10.0 mm ²	28 - 7



Self-adjusting crimping pliers with hexagonal crimp



Crimping pliers with hexagonal crimp for a approximately circular crimping, especially suitable for confined connection dimensions; self-adjusting for automatic adjusting the size of wire ferrules and with ratchet mechanism for repetitive, high crimping quality; reliable hexagonal crimping of wire ferrules or 0.08 to 16 mm² by simply turning and setting the adjusting wheel and all twin wire ferrules up to 2 x 18 mm² (AWG 2 x 8)



dpwlink 8995

Article	L [mm]	Capacity	AWG
K-975314.180	180	0.08 - 16.0 mm ²	6 - 10



Self-adjusting crimping pliers with square crimp



Crimping pliers with square crimp. For the crimping of wire end ferrules; for standard, solderless, electrical connections. Frontal insertion of the wire end ferrules; easy handling by self-adjustment, high ease of use, low weight, constantly high crimping quality due to restraint lock (unlockable); crimping pressure factory-set. Power increase by leverage.



dpwlink 8993

Article	L [mm]	Capacity	AWG
K-975308.190	180	0.08 - 10.0 mm ²	28 - 7



Crimping lever pliers



For solderless electrical connections. New leverage reduces 30% of the manual force compared to customary crimping pliers. Constantly high crimping quality by precision profiles and restraint lock (unlockable). Crimping pressure factory-set. Two-hand operation for large conductor cross-sections, good handling, balanced center of gravity, angled head and ergonomic handles.



dpwlink 8977

Article	L [mm]	Capacity	AWG
K-975204.250	250	0.1 - 2.5 mm ²	27 - 13
K-975205.250	250	0.5 - 6.0 mm ²	20 - 10
K-975206.250	250	0.5 - 6.0 mm ²	20 - 10
K-975208.250	250	0.25 - 6.0 mm ²	23 - 10



Crimping pliers "PeciForce"



For solderless, electrical connections; high crimping quality by precision profiles and restraint lock (unlockable); precisely factory-set crimping pressure (calibrated). High power increase by leverage for low-fatigue work, good handling position, low weight, short, ergonomic design.



dpwlink 8982

Article	L [mm]	Capacity	AWG
K-975230.220	220	1.5 - 10.0 mm ²	15 - 7
K-975233.220	220	0.5 - 10.0 mm ²	20 - 7
K-975234.220	220	0.1 - 2.5 mm ²	27 - 13
K-975235.220	220	0.5 - 6.0 mm ²	20 - 10
K-975236.220	220	0.5 - 6.0 mm ²	20 - 10
K-975237.220	220	0.5 - 6.0 mm ²	20 - 10
K-975238.220	220	0.25 - 6.0 mm ²	23 - 10
K-975250.220	220		



Positioning aids for K-975235.220



dpvlink 9020

Article	Type
K-974994	Positioning aids for K-975235.220
K-974995	Positioning aids for K-975235.220



Crimping pliers for Western plugs



Professional tool for cutting and stripping of flat, unshielded telephone cables. For the crimping of 6- and 8-pin Western plugs (RJ-11 / 12, RJ45). Exact crimping process by parallel crimping; constantly high crimping quality by restraint lock (unlockable), power increase by leverage for low-fatigue work; length cutter and dismantling knife for ribbon cables of 6 and 12 mm length, with stripping function for round cable.



dpvlink 8973

Article		L [mm]
K-975110.190	Crimping pliers for Western plugs RJ 11/12 (6-pin) / RJ 45 (8-pin)	190



Crimping pliers for Western plugs



Professional tool for the cutting and stripping of flat, unshielded telephone cables for the crimping of 4-, 6-, 8-pin Western plugs. (type RJ10, RJ 11 / 12, RJ45). Exact crimping process by parallel crimping. Constantly high crimping quality due to restraint lock (unlockable), power increase by leverage for low-fatigue work; length cutter and dismantling knife for ribbon cables of 6 and 12 mm length.



dpvlink 8975

Article		L [mm]
K-975112.200	Crimping pliers for Western plugs RJ 10 (4-pin) / RJ 11/12 (6-pin) / RJ 45 (8-pin)	200



dpvlink 9018

Article	Type
K-975906	4 replacement blades for K-975112.200



Crimp assortment for cable connectors



Crimp assortments for cable connectors, in the TANOS MINI-systainer® (stable plastic box), with two stackable plastic inserts with 6 trays for connectors, including a range of standard cable connectors

dpvlink 9004

Article	Type
K-979021	Crimp assortment for cable connectors for cable connectors, with crimping pliers K-975236.220 and cable connectors, each with 25 pieces of K-97 99 01 / 02 / 14 / 15 / 16 / 17 / 18 / 34 / 35 and each with 20 pieces of K-97 99 21 / 22 / 36 in the TANOS MINI-systainer®



K-979022	Crimp assortments for cable connectors for cable connectors with crimping pliers K-975236.220, stripping pliers K-1242.195 and cable connectors each with 25 pieces of K-97 99 01 / 02 / 14 / 15 / 16 / 17 / 18 / 34 / 35 and each with 20 pieces of K-97 99 21 / 22 / 36 in the TANOS MINI-systainer®
----------	---

Crimp assortments for wire end ferrules



Crimp assortments for wire end ferrules, in the TANOS MINI-systainer® (stable plastic box), with two stackable plastic inserts with 6 trays for connectors, with an assortment of wire end ferrules with / without plastic collar

dpvlink 9017

Article	Type
K-979023	Crimp assortment for wire end ferrules Crimp assortment for cable connectors ++ KNIPEX++, with K-975236.220 crimping pliers and wire end ferrules, per 200 pieces 0.5 / 0.75 / 1.0 / 1.5 / 2.5 mm ² , per 100 pieces 4.0 / 6.0 mm ² , in the TANOS MINI-systainer®



K-979017	Crimp assortment for wire end ferrules
----------	---

High-precision stripping tool

High-precision stripping tool MiniStrip



The new MiniStrip stripping tool especially designed for cables with small diameters. An absolutely precise and accurate repeatability in the stripping of wire ends is ensured by the four-blade system.

The coating is removed by cutting with rotating blades and strip-off in one single operation, strands are twisted at the same time, depending on the stripping length and cable. This method allows the easy processing of optical fibers, coaxial cables, and teflon-coated cables.



The high-precision stripping tool MiniStrip is quickly adjusted to different diameters and lengths by a calibrated scale. A locking screw allows the blocking of the diameter adjustment. The high-quality processing guarantees an accurate repeatability of the tool.

Properties

- Conductor diameter of 0.16 to 1.5 mm (15-34 AWG), according to insulation type 0.10 mm is possible (38 AWG)
- Maximum cable diameter 2.5 mm
- Stripping length up to 15 mm
- Stripping head with four-blade system
- Rotary cutting
- No damage of the conductors
- Stepless adjustment of diameter and length
- Mobile, can be used anywhere, no power supply required
- Suitable for PVC, Teflon, Kynar, and Kapton insulation

dpvlink 15170

Article	Type
NI-010065	MiniStrip standard with 4 HSS blades
NI-010070	MiniStrip Titan 4 titanium-coated carbide blades and centering device
NI-010131	MiniStrip advanced set (without MiniStrip) Carrying case including table holder and tweezers as well as recesses for MiniStrip and blade sets
NI-010075	Replacement blades HSS Set = 4 pieces
NI-010079	Replacement blades Titan Set = 4 pieces



Other tools

Scalpels and scissors

Scalpel series 1



Scalpel handle and blades for all industrial applications

- high-quality materials - scalpel handle made of aluminium, scalpel blade made of carbon steel
- round handle
- easy exchange of the blades

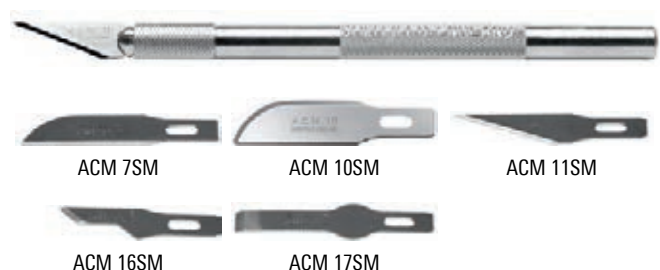

dpvlink 16049

Article	Type	PU
I-ACMH1	Scalpel handle 1 with scalpel blade ACM 11SM	1
I-ACM10SM	Scalpel blade ACM 10SM	5
I-ACM11SM	Scalpel blade ACM 11SM	5
I-ACM16SM	Scalpel blade ACM 16SM	5
I-ACM17SM	Scalpel blade ACM 17SM	5
I-ACM7SM	Scalpel blade ACM 7SM	5



Scalpel series 3



Scalpel handles and blades for all industrial applications

- small blades
- high-quality materials
- ergonomically shaped handle
- easy exchange of the blades



dpvlink 16017

Article	Type	Material	PU
I-HANDLE-3	Scalpel handle 3	Stainless steel	1
I-HANDLE-5A	Scalpel handle 5A	Acrylic / blade holder of nickel	1
I-310	Scalpel blade 310	Carbon steel	5
I-310A	Scalpel blade 310A	Carbon steel	5
I-311	Scalpel blade 311	Carbon steel	5
I-312	Scalpel blade 312	Carbon steel	5
I-313	Scalpel blade 313	Carbon steel	5
I-314	Scalpel blade 314	Carbon steel	5
I-315	Scalpel blade 315	Carbon steel	5



Scalpel series 4



Scalpel handles and blades for all industrial applications

- large blades
- high-quality materials
- ergonomically shaped handles
- easy exchange of the blades



dpvlink 16031

Article	Type	Material	PU
I-HANDLE-4	Scalpel handle 4	Stainless steel	1
I-HANDLE-6A	Scalpel handle 6A	Acrylic / blade holder of nickel	1
I-418	Scalpel blade 418	Carbon steel	5
I-419	Scalpel blade 419	Carbon steel	5
I-420	Scalpel blade 420	Carbon steel	5
I-421	Scalpel blade 421	Carbon steel	5
I-422	Scalpel blade 422	Carbon steel	5
I-423	Scalpel blade 423	Carbon steel	5
I-424	Scalpel blade 424	Carbon steel	5
I-425A	Scalpel blade 425	Carbon steel	5
I-426	Scalpel blade 426	Carbon steel	5
I-436	Scalpel blade 436	Carbon steel	5

Scalpel series 5



Scalpel handles and blades for all industrial applications

- high-quality materials - scalpel handle made of plastic (blade holder made of aluminium), scalpel blade made of carbon steel
- easy exchange of the blades

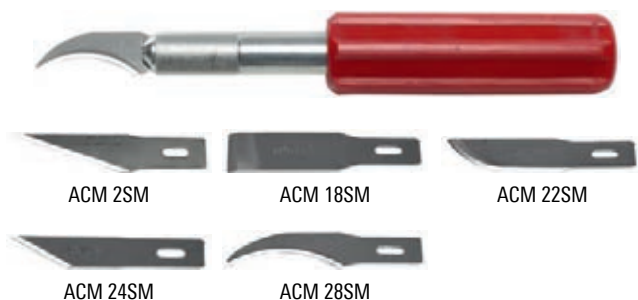

dpvlink 16059

Article	Type	PU
I-ACMH5	Scalpel handle 5 with scalpel blade ACM 28SM	1
I-ACM18SM	Scalpel blade ACM 18SM	5
I-ACM22SM	Scalpel blade ACM 22SM	5
I-ACM24SM	Scalpel blade ACM 24SM	5
I-ACM28SM	Scalpel blade ACM 28SM	5
I-ACM2SM	Scalpel blade ACM 2SM	5

Scalpel Trimaway



Scalpel with plastic handle and fixed blade made of carbon steel

Delivery including blade protection



dpvlink 16069

Article	Type	PU
I-2338	Scalpel Trimaway	1

Scalpel Retractable



Scalpel with metal handle and exchangeable blade made of carbon steel (retractable)

Delivery including 5 x scalpel blade I-310A

Scalpel Retractable can be combined with all scalpel blades of series 3



dpvlink 16071

Article	Type	PU
I-2339	Scalpel Retractable	1

Scalpel set



Scalpel set consisting of:

- scalpel handles 1, 2 and 5
- scalpel blades ACM 2SM (2x), ACM 3SM (2x), ACM 11SM, ACM 7SM, ACM 10SM, ACM 16SM, ACM 17SM, ACM 18SM, ACM 22SM, ACM 24SM and ACM 28SM



dpvlink 16073

Article	Type
I-ACM-Set	Scalpel set

CK



Technician's case with/without basic equipment



Professional case, robust, washable, free-standing; equipped with essential tools; specially protected inside pocket for a notebook or sensitive equipment; two inside pockets for documents with carrying and shoulder straps.

dpvlink 10569

Article	Type
2630MA	Technician's case (without equipment, empty)
1630FKIT	Technician's case with basic equipment small metal saw, cable stripping knife Jokari, automatic stripping pliers, VDE screwdrivers for terminal strips size 1 and 2 (combination PZD/slotted), VDE slotted screwdrivers 3 x 75 mm and 4 x 100 mm, VDE Phillips screwdrivers size 1 and 2, VDE Pozidriv screwdrivers size 1 and 2, voltage tester 65 mm, VDE combination pliers 205 mm, VDE diagonal cutting pliers 160 mm, VDE long-nosed pliers 175 mm, measuring tape 5 M, electrician's knife, universal cross-shaped key, (electrical cabinet key), plasterboard saw

Scissors for fiberglass



Fiberglass scissors especially for Kevlar fiber and many others materials. Blades of high-alloy carbon steel with molybdenum and vanadium blades. Suitable for left- and righthanders.

dpvlink 21576

Article	L [mm]	Weight [g]
4505	160	90

Insertion tool



For the insertion of telecommunication and data cables into terminal clamps; wires are crimped and cut in one single operation; suitable for a variety of different terminal blocks e.g. crowns and similar products; handle contains a wire extractor hook and a grooving tool

dpvlink 10596

Article	Type
495033	Insertion tool

Electrical cabinet key



Universally usable electrical cabinet key for locking systems in the fields of electrical, air-conditioning and ventilation technology, electrical cabinets, etc.; includes 4 inserts, square in 6 and 8 mm, triangular in 8 mm, double wing; a bit adapter for 8 mm square and a double bit for Phillips screws size 2 and slotted screws 1.0 x 7 mm are also supplied

dpvlink 10559

Article	Type
4455	Electrical cabinet key

Cross-shaped key



Universally applicable cross-shaped key for locking systems in the fields of gas and water supply, electrical, industrial, air-conditioning and ventilation, sanitary installations, electrical cabinets, etc.; includes 4 inserts: square 5, 7 and 8 mm, triangular in 8/9 mm and tapered square for sizes from 4 to 10 mm, is delivered with bit adapter for 8 mm square and double bit for Phillips screws size 2 and slotted screws 1.0 x 7 mm

dpvlink 10561

Article	Type
495015	Cross-shaped key

Adjustable wrench



with "Sure Drive" mouth profile - grips the screws heads and nuts at the sides and not at the corners thus avoiding a "spinning"; made of chrome-vanadium steel, matt chromed - especially robust and protected against rust; comfortable soft handle; metric and inch scale / mouth 18% wider than the standard models. With advices concerning the direction of rotation to protect the screws.

dpvlink 10603

Article	L [mm]	Mouth
4365.150	150	24 mm
4365.200	200	28 mm
4365.250	250	33 mm
4365.300	300	38 mm

Inspection mirror



stainless steel; avec adjustable joint; mirror diameter 24 mm, total length 195 mm

dpvlink 10587

Article	L [mm]	Ø
5911.20	164	20 mm

Precision tools

Telescopic inspection mirror



made of stainless steel; with joint adjustable on all sides; with pocket clip

dpvlink 10589

Article	L [mm]	Ø
5912.38	125 - 685	38 mm
5912.55	125 - 560	55 mm



Telescopic inspection mirror 55 mm



made of stainless steel; with joint adjustable on all sides; with plastic handle, mirror diameter 55 mm, length 250-780 mm

dpvlink 10594

Article	L [mm]	Ø
5914.55	250 - 780	55 mm



Telescopic inspection mirror 32 mm



made of stainless steel; with joint adjustable on all sides; with pocket clip; mirror diameter 32 mm, length 180-520 mm

dpvlink 10592

Article	L [mm]	Ø
5913.32	180 - 250	32 mm



Pocket spirit level



Multifunctional pocket spirit level with removable level part; with horizontal and vertical level; with magnetic base; the removable part has also a magnetic base and can be used as line level.

dpvlink 10576

Article	Type
3482	Pocket spirit level



Measuring tape



complies with accuracy class II; made of robust, handy-shaped ABS plastic case with adjusting and stop knob; with belt clip. Tapes with abrasion-resistant nylon coating for wear and corrosion resistance; with metric scale; equipped with recoil dampers (5 m version)

dpvlink 10600

Article	Type
3442.M5	Measuring tape 5 m
3442.M3	Measuring tape 3 m



Wiha



MagicRing® hexagon ballpoint offset screwdriver set

wiha



9-piece set, matt chrome-plated, with MagicRing® of spring steel (from size 3 mm) holds all standard screws in any position, ballpoint allows the screwing at an angle of up to 25°. With space-saving ErgoStar holder for an easy removal.

dpvlink 21865

Article	Type
369R.H9	MagicRing® hexagon ballpoint offset screwdriver set Sizes: 1.5, 2, 2.5, 3, 4, 5, 6, 8, 10



Hexagon L-key set

wiha



11-piece L-key set, nickel-plated, with MagicRing® of chrome-vanadium-steel, compact fits perfectly into any folding rule pocket.

dpvlink 21869

Article	Type
352.H11	Hexagon L-key set Sizes: 1.5, 2, 2.5, 3, 4, 5, 6, 7, 8, 9, 10



TORX® screwdriver set

wiha



13-piece TORX® set, of steel and titanium silver, completely hardened. Simple and quick removal.

dpvlink 21871

Article	Type
366.SZ13TS	TORX® screwdriver set Sizes: TX5, TX6, TX7, TX8, TX9, TX10, TX15, TX20, TX25, TX27, TX30, TX40, TX45



MagicRing® Hexagon L-key set (inch version)

NEU wiha

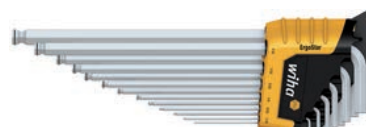

14-piece L-key set, chrome-vanadium-steel, with MagicRing® of spring steel (from 1/8"), holds all standard screws in each position, ballpoint allows the screwing at an angle of up to 25°. Space-saving ErgoStar holder for easy removal

dpvlink 26462

Article	Type
369R.HZ14	MagicRing® Hexagon L-key set (inch version) Sizes: 0.05, 1/16, 5/64, 3/32, 7/64, 1/8, 9/64, 5/32, 3/16, 7/32, 1/4, 5/16, 3/8



Magnetizer



for magnetizing and demagnetizing of blades and similar tools made of steel

dpvlink 10806



Article	Type
400.10	Magnetizer

Dial caliper dialMax® ESD



Scale 0.1 mm, made of electrostatically dissipative material, shock-proof dial, round scale adjustable to zero, comparative measurements possible. Outdoor, indoor, depth and stage measurements, for all working on electrostatically sensitive components.

dpvlink 8633



Article	Type
314392.ESD	Dial calipers dialMax® ESD Scale: 0.1 mm

Hexagon ballpoint MagicRing® PocketStar® fold-out holder



7-piece fold-out holder, galvanically finished blades with MagicRing®, made of spring steel (from size 3 mm); holds all standard screws in each position, ballpoint allows the screwing at an angle of up to 25°.

dpvlink 9559



Article	Type
369R.P7	Hexagon ballpoint MagicRing® PocketStar® fold-out holder Sizes: 2, 2.5, 3, 4, 5, 6, 8

TORX® PocketStar® fold-out holder



8-piece fold-out holder, galvanically finished blades

dpvlink 9563



Article	Type
363.P8	TORX® PocketStar® fold-out holder Sizes: TX9, TX10, TX15, TX20, TX25, TX27, TX30, TX40

TORX® Tamper resistant PocketStar® fold-out holder



8-piece fold-out holder, galvanically finished blades, with hole.

dpvlink 9565



Article	Type
363TR.P8	TORX® Tamper resistant PocketStar® fold-out holder Sizes: TX9H, TX10H, TX15H, TX20H, TX25H, TX27H, TX30H, TX40H

Knipex



Knipex tools made of chrome-vanadium electric steel. In proven quality for individual use.

Pen-style electrical cabinet key



Pen-style electrical cabinet key easy to transport with fixing clip, four different key profiles can be utilized by folding out (square, triangular, double-bit inside/outside). With universal 1/4" bit holder and bit PH2. For electrical cabinets, barrier systems, air conditioning and ventilation systems, shut-off valves, main switchboards etc.

dpvlink 9555



Article	Type
K-001107	Pen-style electrical cabinet key Square 5 / 6 / 8 mm, triangular 9 mm Double-bit ø 5 mm (inside) / ø 9 mm (outside)

Water pump pliers SmartGrip



Automatic adjustment, one-hand operation; fine adjustment for favourable position of the handles; slim design, high stability, self-clamping on the workpiece protects against slipping; trap protection prevents contusions, gripping surfaces with specially hardened teeth (61 HRC), chrome-vanadium electric steel

dpvlink 8916



Article	L [mm]	Nut Ø	Tube Ø
K-8501.250	250	36 mm	1 1/4 inch

Pliers wrench



Ideal for gripping, holding, pressing and bending of workpieces; no damage to edges of sensitive components due to backlash-free contact. Quick adjustment by pushing a button on the workpiece, no accidental adjustment of the gripping jaws; replaces a complete set of wrenches; stepless gripping of all width across flats, action between the gripping jaws allows a fast tightening and release by ratchet principle. High clamping force due to a tenfold increase of the manual force.

dpvlink 9552



Article	L [mm]	Nut Ø	Tube Ø
K-8605.180	180	40 mm	1 1/2 inch
K-8605.250	250	52 mm	2 inch

Hightech water pump pliers Cobra



Quick, comfortable adjustment by pushing a button directly on the workpiece; fine adjustment for optimal adaption, high stability, self-clamping on the workpiece protecting from slipping; clamping protection prevents contusions, gripping surfaces with specially hardened teeth (61 HRC), chrome-vanadium electric steel

dpvlink 8918

Article	L [mm]	Nut Ø	Tube Ø
K-8701.150	150	30 mm	1 1/4 inch
K-8701.180	180	36 mm	1 1/2 inch
K-8701.250	250	46 mm	2 inch
K-8701.300	300	60 mm	2 3/4 inch
K-8701.400	400	95 mm	3 1/2 inch
K-8701.560	560	120 mm	4 1/2 inch



Water pump pliers Cobra...matic



The proven Cobra with automatic adjustment; pliers can be opened with one hand, directly adjustable on the workpiece, closes by pushing a button; integrated spring is protected in the inner part of the handle; gripping surfaces with specially hardened teeth (61 HRC), chrome-vanadium electric steel

dpvlink 8925

Article	L [mm]	Nut Ø	Tube Ø
K-8711.250	250	46 mm	2 inch



Multiple slip joint spanner



Replaces a complete set of wrenches. Backlash-free gripping of metric or imperial hexagon screw heads (no rounding), reliable and tight gripping of rounded, rusty or varnished nuts and screws. Ideal for locking nuts, high stability, trap protection prevents contusions, one-hand fine adjustment.

dpvlink 8936

Article	L [mm]	Nut Ø	Tube Ø
K-8741.250	250	10 - 32 mm	3/8 - 1 1/4 inch



Water pump pliers Cobra ES



Slim design, long, pointed jaws; one-hand fine adjustment via button on the workpiece, reliable locking of joint bolt, no accidental adjustment, high stability, reliable gripping on flat parts by three-point support, self-clamping; trap protection prevents contusions; chrome-vanadium electric steel.

dpvlink 8934

Article	L [mm]	Nut Ø	Tube Ø
K-8751.250	250	34 mm	1 1/4 inch



Water pump pliers Alligator



High stability, self-clamping on tubes and nuts; trap protection prevents contusions, favorable leverage for optimal power transmission, gripping surfaces with specially hardened teeth (61 HRC), chrome-vanadium electric steel.

dpvlink 8928

Article	L [mm]	Nut Ø	Tube Ø
K-8801.180	180	36 mm	1 1/2 inch
K-8801.250	250	46 mm	2 inch
K-8801.300	300	60 mm	2 3/4 inch



Water pump pliers Alligator ISO 1000V



Insulated, VDE tested, high stability, self-clamping on tubes and nuts; trap protection prevents contusions, favorable leverage for optimal power transmission; gripping surfaces with specially hardened teeth (61 HRC), chrome-vanadium electric steel.

dpvlink 8932

Article	L [mm]	Nut Ø	Tube Ø
K-8806.250	250	46 mm	2 inch



Pneumatic cutter

The cutting shapes and cutting performance:



With bevel (facet)

Normal cut. Suitable for cutting hard and soft steel wires as well as soft materials such as copper wire and cable.



Without bevel (facet)

Flush cut. Extremely sharp cutting edges. Only suitable for soft steel wires, copper wire and cable.

Erem pneumatic cutter 1500BSF



The Erem 1500BSF is a small, light and precise pneumatic tool. The variety of different cutting heads makes the pneumatic cutter Erem 1500 BSF a very versatile tool, e.g. for the cutting of conventional components, soft metals or small plastic parts. It requires 4-6 bar oil-free, clean compressed air.

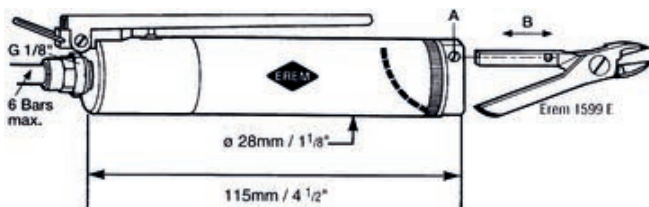

dpvlink 3446

Article	Type
1500BSF	Pneumatic cutter incl. hose, stronger version



Cutting head 1503E



Tip cutter angled by 30°, without bevel, special tool steel, non-reflective; max. CU Ø 1.2 mm



dpvlink 6014

Article	Type
1503E	Cutting head 1503E



Cutting head 1512N



Diagonal cutting pliers, oval head with small bevel, special tool steel, non-reflective, max. CU Ø 1.6 mm

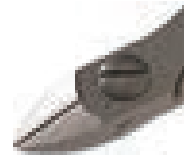

dpvlink 6015

Article	Type
1512N	Cutting head 1512N



Cutting head 1522N



Diagonal cutting pliers, oval head, for planar cut without bevel, special tool steel, non-reflective, max. CU Ø 1.6 mm



dpvlink 6021

Article	Type
1522N	Cutting head 1522N



Cutting head 1522NB



Diagonal cutting pliers, recessed head for better access in narrow places, without bevel, special tool steel, non-reflective, max. CU Ø 1.2 mm



dpvlink 6020

Article	Type
1522NB	Cutting head 1522NB



Cutting head 1522NA



Diagonal cutting pliers, beveled head for a better access in narrow places, without bevel, non-reflective, max. CU Ø 1.4 mm



dpvlink 6018

Article	Type
1522NA	Cutting head 1522NA



Pneumatic cutter

Pneumatic cutter TPP



The pneumatic cutting pliers TPP is a small, precise, handy tool for the cutting of components.
The pneumatic cutting pliers consists of a basic tool that can be equipped with cutting heads.



Technical data:

Compressed air supply: 5-6 bar
Cutting force of the cylinder: 220 N (22 kg)

dpvlink 3406



Article	Type
TPP	Pneumatic cutter TPP without cutting head

Pneumatic cutter TPP complete tool



dpvlink 3408



Article	Type
TPP-Set	Pneumatic cutter TPP, including cutting heads TP-6000/TR-6000/TR-6000-R and carrying case
TPP-TP6000	Pneumatic cutter TPP-TP 6000 cutting & bending, max 1.02 mm 18 AWG, complete
TPP-TP6000-15	Pneumatic cutter TPP TP 6000-15 cutting & bending 30°, max 1.02 mm 18 AWG, complete
TPP-TS6000	Pneumatic cutter TPP-TS 6000 cutting and squeezing, max 1.3 mm 16 AWG, complete
TPP-TR6000	Pneumatic cutter TPP-TR 6000 angle cut, max 1.60 mm 14 AWG, complete
TPP-TR6000-10	Pneumatic cutter TPP-TR 6000-10 cut 1.0 mm above the PCB, max. 1.6 mm 14 AWG, complete
TPP-TR6000-13	Pneumatic cutter TPP-TR 6000-13 cut 1.3 mm above the PCB, max. 1.6 mm 14 AWG, complete
TPP-TR6000-15	Pneumatic cutter TPP-TR 6000-15 cut 1.5 mm above the PCB, max. 1.6 mm 14 AWG, complete
TPP-TR6000R	Pneumatic cutter TPP-TR 6000 R straight cut, max 1.60 mm 14 AWG, complete
TPP-TR6000PR	Pneumatic cutter TPP-TR 6000 PR straight cut / without bevel, max. 1.3 mm 16 AWG, complete

Pneumatic cutter TPP cutting heads, complete



dpvlink 3416



Article	Type
TP-6000	Cutting head TP 6000 for TPP cutting & bending, max 1.02 mm / 18 AWG
TP-6000-15	Cutting head TP 6000-15 for TPP cutting & bending, max 1.02 mm / 18 AWG
TS-6000	Cutting head TS 6000 for TPP cutting and squeezing, max 1.3 mm / 16 AWG
TR-6000	Cutting head TR 6000 for TPP angle cut, max 1.60 mm / 14 AWG
TR-6000-10	Cutting head TR 6000-10 for TPP smooth distance cut 1.0 mm, max 1.6 mm / 14 AWG
TR-6000-13	Cutting head TR 6000-13 for TPP smooth distance cut 1.3 mm, max 1.6 mm / 14 AWG
TR-6000-15	Cutting head TR 6000-15 for TPP smooth distance cut 1.5 mm, max 1.6 mm / 14 AWG
TR-6000-R	Cutting head TR 6000 R for TPP straight cut, max 1.6 mm / 14 AWG
TR-6000-PR	Cutting head TR 6000 PR for TPP smooth cut, max 1.3 mm / 16 AWG

Replacement blade for cutting heads pneumatic cutter TPP



dpvlink 15438



Article	Type
TSR-6000	Replacement blade for cutting head TP 6000 cutting & bending, max 1.02 mm / 18 AWG
TSR-6000-15	Replacement blade for cutting head TP 6000-15 cutting and bending, max 1.02 mm / 18 AWG
CL-TS-6000	Replacement blade for cutting head TS 6000 cutting and squeezing, max 1.3 mm / 16 AWG
CL-6000	Replacement blade for cutting head TR 6000 angle cut / with bevel, max. 1.60 mm / 14 AWG
CL-6000-10	Replacement blade for cutting head TR 6000-10 smooth distance cut 1.0 mm, max 1.6 mm / 14 AWG
CL-6000-13	Replacement blade for cutting head TR 6000-13 smooth distance cut 1.3 mm, max 1.6 mm / 14 AWG
CL-6000-15	Replacement blade for cutting head TR 6000-15 smooth distance cut 1.5 mm, max 1.6 mm / 14 AWG
CL-6000-R	Replacement blade for cutting head TR 6000 R for TPP straight cut, max 1.6 mm / 14 AWG
CL-6000-PR	Replacement blade for cutting head TR 6000 PR smooth cut, max 1.3 mm / 16 AWG

Processing tools

Zipp-Zapp

Special pliers for removing plugs on packaging rails



Application:
Place the Zipp-Zapp vertically and close it.
When closing the pliers, razor-sharp grippers slide under the head of the plug. A receiving pocket holds the plug tight so that it cannot fall into the machines and devices.
Tilt the Zipp Zapp sideways.

dpvlink 2403

Article	Type
8860002.DPV	Zipp-Zapp



PLCC Extractor



Universally usable for all PLCC components (20-124 pins); made of dissipative plastic; hooks made of stainless, hardened steel; for the use in ESD areas; with spring for an automatic opening.



dpvlink 10598

Article	Type
2371	PLCC Extractor



Handling systems

VAMPIRE vacuum pipette

VAMPIRE pick-up tool



The pick-up tool "VAMPIRE" is a handy and battery-free tool, ideal for the handling and positioning of SMD components. Excellent suction capacity and its high-performance suction nozzles allow the lifting of components up to the weight of 120 g. Due to the electrical conductivity of all components, the pick-up tool "VAMPIRE" can be used in ESD protected areas.

Scope of delivery:

- pick-up tool "VAMPIRE" (ESD compatible)
- ESD suction nozzle straight
- ESD suction nozzle bent 45°
- 3 x ESD suction cup Ø 4 mm, Ø 6 mm and Ø 9 mm
- lubricant set

dpvlink 15168

Article	Type
694.200	VAMPIRE pick-up tool



PEN-VAC and accessories



With this PEN-VAC, a vacuum pipette without external pump, it is possible to lift, to transport and putting down small components with a smooth surface up to a weight of 200 g. The pipette itself has a weight of less than 50 g. It is smaller than a ballpoint pen and is equipped with a clip. A reserve sleeve for suction nozzles and rubber is available.

PEN-VAC-ORIGINAL vacuum pipette

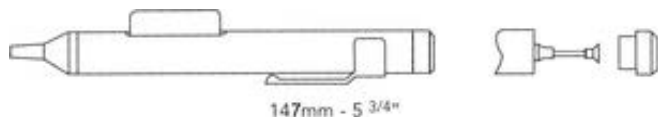

Complete set, including 6 suction nozzles (straight and bent in \varnothing 9.53 mm, \varnothing 6.35 mm, \varnothing 3.18 mm)

dpvlink 2232

Article Type

694.030 **PEN-VAC ORIGINAL - V8901-LMS-ESD.Set**
Length 147 mm, incl. 6 suction nozzles

694.031 **PEN-VAC ORIGINAL - V8901-ESD**
Length 147 mm, without suction nozzles / suction cups

PEN-VAC PRO SERIES vacuum pipette



Set complete, including 4 suction nozzles (\varnothing 9.53 mm, 2 x \varnothing 6.35 mm, \varnothing 3.18 mm)

dpvlink 7673

Article Type

694.005 **PEN-VAC PRO SERIES - V8910-ESD.Set**
Length 127 mm, incl. 4 suction nozzles

694.006 **PEN-VAC PRO SERIES - V8910-ESD**
Length 127 mm, without suction nozzles / suction cups

HANDY-VAC



Set, complete with 4 or 6 suction nozzles

dpvlink 7679

Article Type

694.000 **HANDY-VAC "KIT" HV-6/ESD**
Length 70 mm, incl. 6 suction nozzles (straight and bent in \varnothing 9.53 mm, \varnothing 6.35 mm, \varnothing 3.18 mm)

694.002 **HANDY-VAC "KIT" HV-4/ESD**
Length 70 mm, incl. 4 suction nozzles (1 suction nozzles in \varnothing 9.53 mm, \varnothing 6.35 mm, \varnothing 3.18 mm bent by 45° + 1 suction nozzle \varnothing 6.35 mm straight)

694.001 **HANDY-VAC - ESD**
Length 70 mm, without suction nozzles / suction cups

PAC-VAC portable ESD



Portable vacuum handling system, battery-operated (9V alkaline, 8 hours operating time), with 1.2 m spiral hose wire (\varnothing 1.6 mm), set with 7 vacuum tips VCS-7-B, vacuum pipette V3020-RF-1/16, with belt / pocket clip on the housing, weight 156 g.

dpvlink 12212

Article Type

694.120 **PAC-VAC Portable ESD**

ESD suction nozzles with suction cup - accessories/replacement



The ESD suction nozzles with suction cup are suitable for the use up to 230°C (445°F). Can be used for other systems due to standard socket.

dpvlink 2236

Article Version Diameter

694.044BB	straight	2.38 mm
694.045BB	bent	2.38 mm
694.032	straight	3.18 mm
694.033	bent	3.18 mm
694.046	straight	4.76 mm
694.047	bent	4.76 mm
694.034	straight	6.35 mm
694.035	bent	6.35 mm
694.036	straight	9.53 mm
694.037	bent	9.53 mm
694.038	straight	12.70 mm
694.039	bent	12.70 mm
694.040	straight	15.88 mm
694.041	bent	15.88 mm
694.042	straight	19.05 mm
694.043	bent	19.05 mm

ESD suction cups accessories/replacement



The ESD suction cups are suitable for the use up to 230°C (445°F).

dpvlink 7657

Article Version Diameter

694.045-BB.S	standard	2.38 mm
694.033.S	standard	3.18 mm
694.047.S	standard	4.76 mm
694.035.S	standard	6.35 mm
694.037.S	standard	9.53 mm
694.039.S	standard	12.70 mm
694.041.S	standard	15.88 mm
694.043.S	standard	19.05 mm